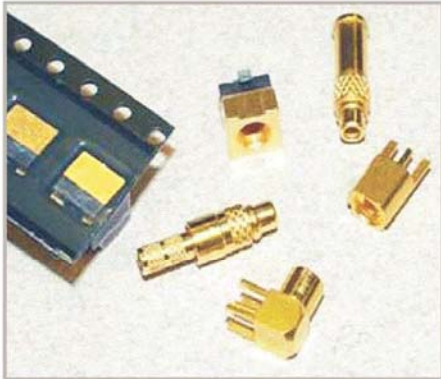
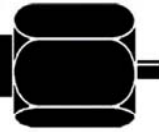


MICROWAVE

C O M P O N E N T S



PRODUCT CATALOG 2008



MICROWAVE COMPONENTS

3171 SE DOMINICA TERRACE

STUART, FL 34997

CALL US AT

(772) 286-4455

(800) 282-4771

FAX: (772) 286-4496

E-mail: admin@microwavecomponentsinc.com

Web: www.microwavecomponentsinc.com

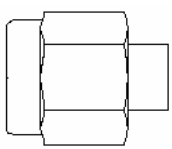
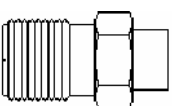
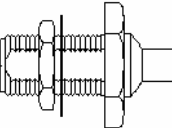
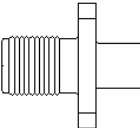
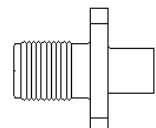
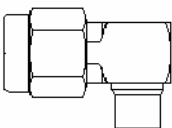
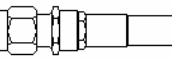


MICROWAVE C O M P O N E N T S

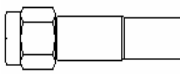
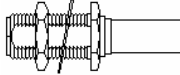
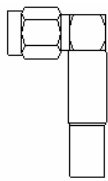

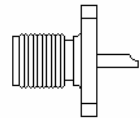
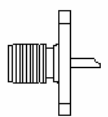
TABLE OF CONTENTS

	<u>PAGE</u>
ADAPTERS:	
ADAPTER CROSS-REFERENCE GUIDE	25
ADAPTER, BETWEEN SERIES.....	37
ADAPTER, IN-SERIES.....	27
ATTENUATORS:	
2.4MM.....	55
2.9MM.	55
BNC	56
SMA.....	53
N.....	55
CABLE FLEXIBLE & SEMI-RIGID.....	59
CAPS:	
OPEN.....	52
SHORTING.....	52
DIRECTIONAL COUPLERS.....	57
MOUNTING PATTERNS.....	103
POWER DIVIDERS:	
TWO-WAY.....	58
FOUR-WAY.....	58
SERIES:	
2.9MM.....	19
BNC	23
MCX.....	20
MMCX.....	21
SMA.....	3
SMB.....	9
SMC.....	13
SSMA.....	7
SSMB.....	15
SSMC.....	17
SMP.....	19
TNC.....	24
TYPE N.....	22
STANDARD CABLE ASSEMBLIES.....	62
TERMINATIONS.....	51
TEST & MEASUREMENT CABLE ASSEMBLIES.....	60

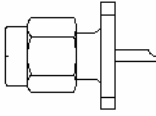
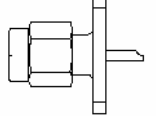
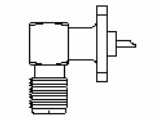
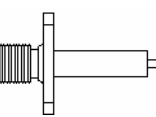
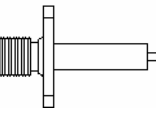
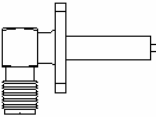
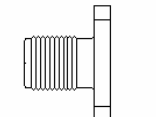
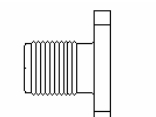
SMA Series

	MODEL#	DESCRIPTION / CABLE TYPE	1-24	25-49	50-99	100+
	MC2113	DIRECT SOLDER / .034 SEMI-RIGID	10.55	9.75	9.05	8.60
	MC2114	DIRECT SOLDER / .047 SEMI-RIGID	10.55	9.75	9.05	8.60
	MC2002	DIRECT SOLDER / RG405	4.50	3.70	3.30	3.00
	MC2112	DIRECT SOLDER / RG405 LOW-LOSS	31.90	26.40	20.90	15.50
	MC2000	DIRECT SOLDER (W/O CONTACT) / RG402	5.25	4.25	3.85	3.50
	MC2001	DIRECT SOLDER / RG402	5.95	5.20	4.20	3.80
	MC2081	DIRECT SOLDER / RG402 LOW-LOSS	14.55	12.25	9.90	8.45
	MC2111	CRIMP (W/O CONTACT) / RG402	5.50	4.95	4.35	3.90
	MC2115	DIRECT SOLDER / RG401	29.95	27.85	25.75	23.95
PLUG						
	MODEL#	DESCRIPTION / CABLE TYPE	1-24	25-49	50-99	100+
	MC2116	DIRECT SOLDER / .034 SEMI-RIGID	17.00	15.80	15.20	14.59
	MC2117	DIRECT SOLDER / .047 SEMI-RIGID	17.00	15.80	15.20	14.59
	MC2003	DIRECT SOLDER / RG402	6.50	6.00	5.50	5.00
	MC2004	DIRECT SOLDER / RG405	6.50	5.60	5.45	5.20
JACK						
	MODEL#	DESCRIPTION / CABLE TYPE	1-24	25-49	50-99	100+
	MC2005	DIRECT SOLDER / RG402	10.15	9.40	8.75	8.50
	MC2006	DIRECT SOLDER / RG405 USE MOUNTING #67	10.15	9.40	8.75	8.50
BULKHEAD JACK						
	MODEL#	DESCRIPTION / CABLE TYPE	1-24	25-49	50-99	100+
	MC2118	DIRECT SOLDER / .047 SEMI-RIGID	15.95	14.80	14.50	13.05
	MC2009	DIRECT SOLDER / RG405	13.95	12.75	10.85	10.50
	MC2007	DIRECT SOLDER / RG402 USE MOUNTING #92	13.95	12.75	10.85	10.35
2-HOLE PANEL JACK						
	MODEL#	DESCRIPTION / CABLE TYPE	1-24	25-49	50-99	100+
	MC2144	DIRECT SOLDER / .047 SEMI-RIGID	15.95	14.80	14.50	13.05
	MC2010	DIRECT SOLDER / RG405	13.95	12.75	10.85	10.50
	MC2008	DIRECT SOLDER / RG402 USE MOUNTING #05	13.95	12.75	10.85	10.50
4-HOLE PANEL JACK						
	MODEL#	DESCRIPTION / CABLE TYPE	1-24	25-49	50-99	100+
	MC2011	DIRECT SOLDER / RG402 12GHZ	13.30	10.80	9.60	9.15
	MC2012	DIRECT SOLDER / RG405 12GHZ	13.30	10.80	9.60	9.15
	MC2088	DIRECT SOLDER / RG402 18GHZ	16.50	15.30	13.50	11.10
	MC2089	DIRECT SOLDER / RG405 18GHZ	16.50	15.30	13.50	12.05
RIGHT-ANGLE PLUG						
	MODEL#	DESCRIPTION / CABLE TYPE	1-24	25-49	50-99	100+
	MC2091	CRIMP/CLAMP / RG58,142,223,400	12.95	12.15	10.95	10.55
MC2119	CRIMP/CLAMP / RG174,188,316	11.95	11.15	10.30	9.55	
PLUG						

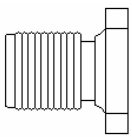
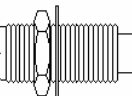
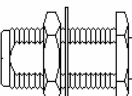
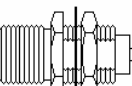
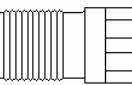
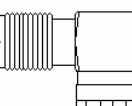
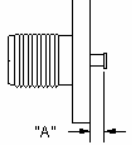
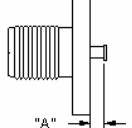
SMA Series

 PLUG	<u>MODEL#</u> MC2013 MC2014 MC2015 MC2016 MC2017 MC2120	<u>DESCRIPTION / CABLE TYPE</u> DIRECT SOLDER / RG55,58,141,142,223,303,400 CRIMP / RG55,142,223,400 CRIMP / RG58,141,303 DIRECT SOLDER / RG174,188,316 CRIMP / RG174,188,316 CRIMP / RD316	<u>1-24</u> 7.85 8.00 7.50 6.95 6.30 8.00	<u>25-49</u> 7.30 7.75 7.25 6.75 6.15 7.20	<u>50-99</u> 6.80 7.10 6.45 5.95 5.45 6.10	<u>100+</u> 6.40 6.65 5.95 5.45 4.95 5.20		
	 BULKHEAD JACK	<u>MODEL#</u> MC2024 MC2027	<u>DESCRIPTION / CABLE TYPE</u> CRIMP / RG58,142,223,400 CRIMP / RG174,188,316 USE MOUNTING #67	<u>1-24</u> 10.95 10.95	<u>25-49</u> 10.15 10.15	<u>50-99</u> 9.45 9.45	<u>100+</u> 8.75 8.75	
		 RIGHT-ANGLE PLUG	<u>MODEL#</u> MC2028 MC2029 MC2030 MC2031 MC2032 MC2094 MC2121	<u>DESCRIPTION / CABLE TYPE</u> DIRECT SOLDER / RG55,58,141,142,223,303,400 CRIMP / RG55,142,223,400 CRIMP / RG58,141,303 DIRECT SOLDER / RG174,188,316 CRIMP / RG174,188,316 CRIMP / RG178,196 CRIMP / RD316	<u>1-24</u> 10.15 10.15 10.15 10.15 10.15 10.15 10.15	<u>25-49</u> 9.15 9.15 9.15 9.15 9.15 9.15 9.15	<u>50-99</u> 8.20 8.20 8.20 8.20 8.20 8.20 8.20	<u>100+</u> 7.40 7.40 7.40 7.40 7.40 7.40 7.40
			 PLUG	<u>MODEL#</u> MC2033 MC2034	<u>DESCRIPTION / CABLE TYPE</u> CLAMP / RG55,58,141,142 CLAMP / RG174,188,316	<u>1-24</u> 14.95 14.95	<u>25-49</u> 13.90 13.90	<u>50-99</u> 12.85 12.85
	 4-HOLE JACK			<u>MODEL#</u> MC2039	<u>DESCRIPTION</u> SOLDER CUP USE MOUNTING#05	<u>1-24</u> 6.95	<u>25-49</u> 5.45	<u>50-99</u> 4.75
	 2-HOLE JACK		<u>MODEL#</u> MC2040	<u>DESCRIPTION</u> SOLDER CUP USE MOUNTING#92	<u>1-24</u> 7.30	<u>25-49</u> 6.55	<u>50-99</u> 5.85	<u>100+</u> 5.10

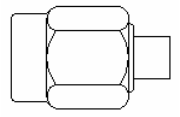
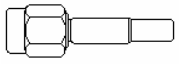
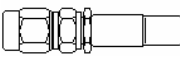
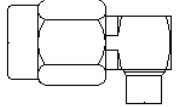
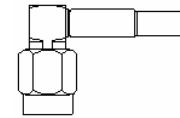
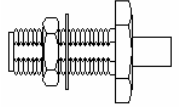
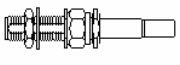
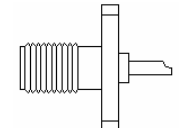
SMA Series

	MODEL# MC2041	DESCRIPTION SOLDER CUP USE MOUNTING #05	1-24 11.95	25-49 11.00	50-99 10.60	100+ 9.50
4-HOLE PLUG						
	MODEL# MC2042	DESCRIPTION SOLDER CUP USE MOUNTING #92	1-24 14.00	25-49 12.50	50-99 10.95	100+ 10.40
2-HOLE PLUG						
	MODEL# MC2122	DESCRIPTION SOLDER CUP USE MOUNTING #05	1-24 15.80	25-49 13.75	50-99 12.70	100+ 11.40
4-HOLE R/A FLANGE JACK						
	MODEL# MC2043	DESCRIPTION DIELECTRIC EXTENSION .590 USE MOUNTING #05	1-24 7.50	25-49 5.90	50-99 5.15	100+ 4.60
4-HOLE FLANGE JACK						
	MODEL# MC2044	DESCRIPTION DIELECTRIC EXTENSION .590 USE MOUNTING #92	1-24 7.95	25-49 6.10	50-99 5.45	100+ 4.90
2-HOLE FLANGE JACK						
	MODEL# MC2047	DESCRIPTION DIELECTRIC EXTENSION .590 USE MOUNTING #05	1-24 15.80	25-49 13.75	50-99 11.00	100+ 9.85
4-HOLE R/A FLANGE JACK						
	MODEL# MC2123 MC2124 MC2125 MC2126 MC2127	DESCRIPTION W/O GASKET,ACCEPTS .020 PIN W/O GASKET,ACCEPTS .036 PIN W/GASKET,ACCEPTS .012 PIN W/GASKET,ACCEPTS .015 PIN W/GASKET,ACCEPTS .018 PIN USE MOUNTING #92	1-24 8.35 8.95 10.50 10.50 10.50	25-49 7.85 8.25 8.95 8.95 9.95	50-99 7.30 7.70 7.95 7.95 8.45	100+ 6.95 7.20 6.95 6.95 7.85
2-HOLE PANEL JACK						
	MODEL# MC2128 MC2129 MC2130 MC2131 MC2132	DESCRIPTION W/O GASKET,ACCEPTS .020 PIN W/O GASKET,ACCEPTS .036 PIN W/GASKET,ACCEPTS .012 PIN W/GASKET,ACCEPTS .015 PIN W/GASKET,ACCEPTS .018 PIN USE MOUNTING #05	1-24 9.50 9.50 11.00 13.00 13.00	25-49 8.85 8.85 9.80 11.10 12.20	50-99 7.30 7.30 8.55 9.85 10.60	100+ 6.95 6.95 7.45 7.40 9.20
.500 SQ 4-HOLE PANEL JACK						

SMA Series

 .375 SQ 4-HOLE PANEL JACK	MODEL#	DESCRIPTION	1-24	25-49	50-99	100+
	MC2133	W/GASKET,ACCEPTS .012 PIN	13.10	12.20	10.60	9.20
	MC2134	W/GASKET,ACCEPTS .015 PIN	13.10	12.20	10.60	9.20
	MC2135	W/GASKET,ACCEPTS .018 PIN	13.10	12.20	10.60	9.20
	MC2136	W/O GASKET,ACCEPTS .020 PIN	13.10	12.20	10.60	9.20
	MC2137	W/O GASKET,ACCEPTS .036 PIN USE MOUNTING #91	13.10	12.20	10.60	9.20
 JACK RECEPTACLE	MODEL#	DESCRIPTION	1-24	25-49	50-99	100+
	MC2048	JACK RECEPTACLE USE MOUNTING #82	10.65	7.95	6.95	6.45
 FRONT MOUNT BULKHEAD	MODEL#	DESCRIPTION	1-24	25-49	50-99	100+
	MC2049	SOLDER CUP/.125 MAX/FRONT MOUNT USE MOUNTING #67	10.65	7.95	6.95	6.15
 REAR MOUNT BULKHEAD	MODEL#	DESCRIPTION	1-24	25-49	50-99	100+
	MC2050	SOLDER CUP/.125 MAX/REAR MOUNT USE MOUNTING #67	10.65	7.95	6.95	6.15
 PCB JACK	MODEL#	DESCRIPTION	1-24	25-49	50-99	100+
	MC2051	PCB JACK USE MOUNTING #PCB05	8.95	8.35	8.10	7.80
 RIGHT-ANGLE PCB JACK	MODEL#	DESCRIPTION	1-24	25-49	50-99	100+
	MC2052	PCB JACK/RIGHT-ANGLE USE MOUNTING #PCB05	10.95	10.15	9.40	8.75
 STRIPLINE JACK	MODEL#	DESCRIPTION	1-24	25-49	50-99	100+
	MC2138	DIAMETER 'A' .031 8 HOLES 0-80 .300BC	25.10	21.40	19.25	17.00
	MC2140	DIAMETER 'A' .063 8 HOLES 0-80 .300BC	25.10	21.40	19.25	17.00
	MC2142	DIAMETER 'A' .125 8 HOLES 0-80 .300BC	25.10	21.40	19.25	17.00
 STRIPLINE JACK	MODEL#	DESCRIPTION	1-24	25-49	50-99	100+
	MC2139	DIAMETER 'A' .031 8 HOLES 2-56 .438BC	27.55	23.40	20.70	18.35
	MC2141	DIAMETER 'A' .063 8 HOLES 2-56 .438BC	27.55	23.40	20.70	18.35
	MC2143	DIAMETER 'A' .125 8 HOLES 2-56 .438BC	27.55	23.40	20.70	18.35

SSMA Series

	MODEL# MC2161	DESCRIPTION / CABLE TYPE PLUG DIRECT SOLDER / RG405	1-24 14.50	25-49 12.15	50-99 10.75	100+ 9.45
	MODEL# MC2162 MC2163	DESCRIPTION / CABLE TYPE PLUG CRIMP / RG178,196 PLUG CRIMP / RG174,188,316	1-24 CONSULT FACTORY	25-49 CONSULT FACTORY	50-99 CONSULT FACTORY	100+ CONSULT FACTORY
	MODEL# MC2168 MC2169	DESCRIPTION / CABLE TYPE PLUG CRIMP/CLAMP / RG178,196 PLUG CRIMP/CLAMP / RG174,88,316	1-24 CONSULT FACTORY	25-49 CONSULT FACTORY	50-99 CONSULT FACTORY	100+ CONSULT FACTORY
	MODEL# MC2164	DESCRIPTION / CABLE TYPE RIGHT-ANGLE PLUG, DIRECT SOLDER / RG405	1-24 30.90	25-49 29.80	50-99 26.10	100+ 23.30
	MODEL# MC2165 MC2166	DESCRIPTION / CABLE TYPE RIGHT-ANGLE PLUG, CRIMP / RG178,196 RIGHT-ANGLE PLUG, CRIMP / RG174,188,316	1-24 CONSULT FACTORY	25-49 CONSULT FACTORY	50-99 CONSULT FACTORY	100+ CONSULT FACTORY
	MODEL# MC2167	DESCRIPTION / CABLE TYPE BULKHEAD JACK, SOLDER / RG405 USE MOUNTING #68	1-24 43.50	25-49 32.25	50-99 28.70	100+ 25.10
	MODEL# MC2170 MC2171	DESCRIPTION / CABLE TYPE BULKHEAD JACK CRIMP/CLAMP / RG178,196 BULKHEAD JACK CRIMP/CLAMP / RG174,188,316 USE MOUNTING #68	1-24 CONSULT FACTORY	25-49 CONSULT FACTORY	50-99 CONSULT FACTORY	100+ CONSULT FACTORY
	MODEL# MC2172	DESCRIPTION 2-HOLE PANEL JACK, SOLDER CUP USE MOUNTING #96	1-24 CONSULT FACTORY	25-49 CONSULT FACTORY	50-99 CONSULT FACTORY	100+ CONSULT FACTORY

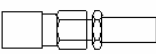
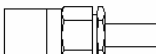
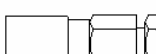
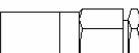
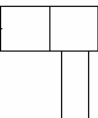
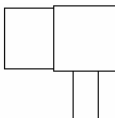
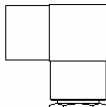
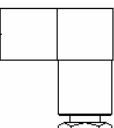
SSMA Series

	<u>MODEL#</u> MC2173	<u>DESCRIPTION</u> 4-HOLE PAN JACK PROBE TEFLON .375 USE MOUNTING #91A	<u>1-24</u>	<u>25-49</u>	<u>50-99</u>	<u>100+</u>
CONSULT FACTORY						
	<u>MODEL#</u> MC2174	<u>DESCRIPTION</u> BULKHEAD JACK, HERMETIC USE MOUNTING #68	<u>1-24</u>	<u>25-49</u>	<u>50-99</u>	<u>100+</u>
			72.75	65.50	58.95	53.05
	<u>MODEL#</u> MC2175	<u>DESCRIPTION</u> BULKHEAD JACK, SOLDER CUP USE MOUNTING #68	<u>1-24</u>	<u>25-49</u>	<u>50-99</u>	<u>100+</u>
			CONSULT FACTORY			
	<u>MODEL#</u> MC2176	<u>DESCRIPTION</u> PCB JACK USE MOUNTING #PCB05	<u>1-24</u>	<u>25-49</u>	<u>50-99</u>	<u>100+</u>
			33.00	29.70	23.75	19.00

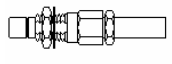
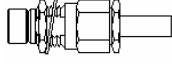
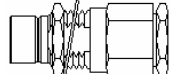
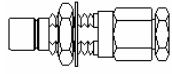
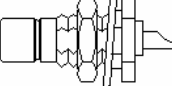
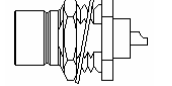
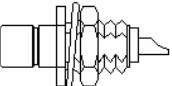
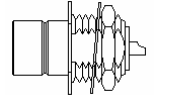
Microwave Components offers the industry the broadest range of Mil-Approved (QPL) Connectors in accordance with Mil-PRF-39012 and Adapters in accordance with Mil-PRF-55339. A large variety of configurations in Type N, TNC, BNC, SMA, SMB, and SMC are readily available from stock.

Contact our Sales Department for Price & Delivery at 1-800-282-4771 or email us at admin@microwavecomponentsinc.com

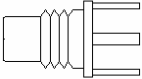
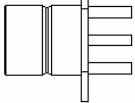
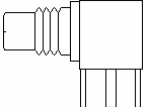
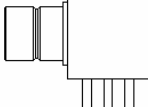
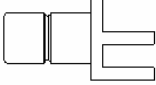
SMB Series

	MODEL#	DESCRIPTION / CABLE TYPE	1-24	25-49	50-99	100+
	MC5001	50 OHM CRIMP/CLAMP / RG174,188,316	7.50	6.00	5.75	5.45
	MC5002	50 OHM CRIMP/CLAMP / RG178,196	7.50	6.00	5.75	5.45
	MC5109	50 OHM CRIMP/CLAMP / RD316	7.50	6.00	5.75	5.00
PLUG						
	MODEL#	DESCRIPTION / CABLE TYPE	1-24	25-49	50-99	100+
	MC5005	75 OHM CRIMP/CLAMP / RG179	9.95	9.25	8.55	7.95
	MC5006	75 OHM CRIMP/CLAMP / RG180,195	9.95	9.25	8.55	7.95
PLUG						
	MODEL#	DESCRIPTION / CABLE TYPE	1-24	25-49	50-99	100+
	MC5009	50 OHM CLAMP / RG174,188,316	6.95	6.45	5.95	5.55
	MC5010	50 OHM CLAMP / RG178,196	6.95	6.45	5.95	5.55
	MC5011	50 OHM SOLDER/CLAMP / RG402	11.50	9.90	8.95	7.45
	MC5111	50 OHM SOLDER/CLAMP / RG405	11.10	8.90	7.95	6.95
PLUG						
	MODEL#	DESCRIPTION / CABLE TYPE	1-24	25-49	50-99	100+
	MC5015	75 OHM CLAMP / RG180,195	8.95	7.85	7.00	6.35
	MC5016	75 OHM CLAMP / RG179	8.95	7.85	7.00	6.35
PLUG						
	MODEL#	DESCRIPTION / CABLE TYPE	1-24	25-49	50-99	100+
	MC5019	50 OHM CRIMP / RG174,188,316	13.05	10.50	9.30	8.15
	MC5020	50 OHM CRIMP / RG178,196	13.05	10.50	9.30	8.15
	MC5113	50 OHM CRIMP / RD316	13.05	10.50	9.30	8.15
RIGHT-ANGLE PLUG						
	MODEL#	DESCRIPTION / CABLE TYPE	1-24	25-49	50-99	100+
	MC5023	75 OHM CRIMP / RG179	18.65	15.85	14.10	12.35
	MC5024	75 OHM CRIMP / RG180,195	18.65	15.85	14.10	12.35
RIGHT-ANGLE PLUG						
	MODEL#	DESCRIPTION / CABLE TYPE	1-24	25-49	50-99	100+
	MC5033	75 OHM CLAMP / RG179	25.95	22.05	18.75	15.95
	MC5034	75 OHM CLAMP / RG180,195	25.95	22.05	18.75	15.95
RIGHT-ANGLE PLUG						
	MODEL#	DESCRIPTION / CABLE TYPE	1-24	25-49	50-99	100+
	MC5027	50 OHM CLAMP / RG174,188,316	9.70	8.75	7.80	6.95
	MC5028	50 OHM CLAMP / RG178,196	9.70	8.75	7.80	6.95
	MC5115	50 OHM CLAMP / RD316	9.70	8.75	7.80	6.95
	MC5116	50 OHM SOLDER/CLAMP / RG402	12.65	10.75	9.55	8.35
	MC5029	50 OHM SOLDER/CLAMP / RG405	12.65	10.75	9.55	8.35
RIGHT-ANGLE PLUG						

SMB Series

 BULKHEAD JACK	<u>MODEL#</u>	<u>DESCRIPTION / CABLE TYPE</u>	<u>1-24</u>	<u>25-49</u>	<u>50-99</u>	<u>100+</u>
	MC5037	50 OHM CRIMP/CLAMP / RG174,188,316	11.60	11.00	10.45	9.28
	MC5038	50 OHM CRIMP/CLAMP / RG178,196	11.60	11.00	10.45	9.28
	MC5119	50 OHM CRIMP/CLAMP / RD316	11.60	11.00	10.45	9.28
USE MOUNTING #68						
 BULKHEAD JACK	<u>MODEL#</u>	<u>DESCRIPTION / CABLE TYPE</u>	<u>1-24</u>	<u>25-49</u>	<u>50-99</u>	<u>100+</u>
	MC5041	75 OHM CRIMP/CLAMP / RG179	16.45	15.25	14.10	13.25
	MC5042	75 OHM CRIMP/CLAMP / RG180,195	16.45	15.25	14.10	13.25
	USE MOUNTING #97					
 BULKHEAD JACK	<u>MODEL#</u>	<u>DESCRIPTION / CABLE TYPE</u>	<u>1-24</u>	<u>25-49</u>	<u>50-99</u>	<u>100+</u>
	MC5051	75 OHM CLAMP / RG179	16.45	15.25	14.10	13.25
	MC5052	75 OHM CLAMP / RG180, 195	16.45	15.25	14.10	13.25
	USE MOUNTING #97					
 BULKHEAD JACK	<u>MODEL#</u>	<u>DESCRIPTION / CABLE TYPE</u>	<u>1-24</u>	<u>25-49</u>	<u>50-99</u>	<u>100+</u>
	MC5045	50 OHM CLAMP / RG174,188,316	7.95	7.35	6.85	6.35
	MC5046	50 OHM CLAMP / RG178,196	7.95	7.35	6.85	6.35
	MC5121	50 OHM SOLDER CLAMP / RG402	7.95	7.35	6.85	6.35
	MC5047	50 OHM SOLDER CLAMP / RG405	7.95	7.35	6.85	6.35
USE MOUNTING #68						
 JACK RECEPTACLE	<u>MODEL#</u>	<u>DESCRIPTION</u>	<u>1-24</u>	<u>25-49</u>	<u>50-99</u>	<u>100+</u>
	MC5055	50 OHM SOLDER CUP REAR MOUNT USE MOUNTING #68	4.00	3.70	3.40	3.20
 JACK RECEPTACLE	<u>MODEL#</u>	<u>DESCRIPTION</u>	<u>1-24</u>	<u>25-49</u>	<u>50-99</u>	<u>100+</u>
	MC5057	75 OHM SOLDER CUP REAR MOUNT USE MOUNTING #97	10.35	9.65	8.45	7.50
 JACK RECEPTACLE	<u>MODEL#</u>	<u>DESCRIPTION</u>	<u>1-24</u>	<u>25-49</u>	<u>50-99</u>	<u>100+</u>
	MC5059	50 OHM SOLDER CUP FRONT MOUNT USE MOUNTING #68	4.00	3.70	3.40	3.20
 JACK RECEPTACLE	<u>MODEL#</u>	<u>DESCRIPTION</u>	<u>1-24</u>	<u>25-49</u>	<u>50-99</u>	<u>100+</u>
	MC5061	75 OHM SOLDER CUP FRONT MOUNT USE MOUNTING #97	10.35	9.65	8.45	7.50

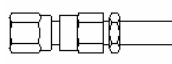
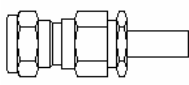
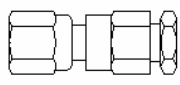
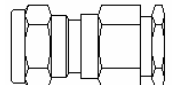
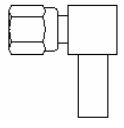
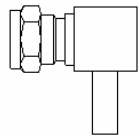
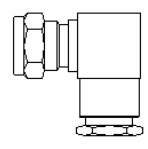
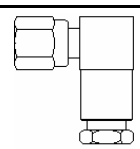
SMB Series

	<u>MODEL#</u> MC5067	<u>DESCRIPTION / CABLE TYPE</u> 50 OHM JACK, PCB USE MOUNTING #PCB06	<u>1-24</u> 4.85	<u>25-49</u> 4.15	<u>50-99</u> 3.70	<u>100+</u> 3.50
PCB JACK						
	<u>MODEL#</u> MC5069	<u>DESCRIPTION</u> 75 OHM JACK, PCB USE MOUNTING #PCB06	<u>1-24</u> 5.50	<u>25-49</u> 4.85	<u>50-99</u> 4.30	<u>100+</u> 4.20
PCB JACK						
	<u>MODEL#</u> MC5071	<u>DESCRIPTION</u> 50 OHM R/A JACK, PCB USE MOUNTING #PCB06	<u>1-24</u> 9.95	<u>25-49</u> 8.50	<u>50-99</u> 7.40	<u>100+</u> 6.30
RIGHT-ANGLE PCB JACK						
	<u>MODEL#</u> MC5073	<u>DESCRIPTION</u> 75 OHM R/A JACK, PCB USE MOUNTING #PCB06	<u>1-24</u> 14.75	<u>25-49</u> 12.55	<u>50-99</u> 10.95	<u>100+</u> 9.50
RIGHT-ANGLE PCB JACK						
	<u>MODEL#</u> MC5123	<u>DESCRIPTION / CABLE TYPE</u> 50 OHM END LAUNCH PCB .062	<u>1-24</u> 7.65	<u>25-49</u> 6.50	<u>50-99</u> 5.55	<u>100+</u> 4.80
END LAUNCH PCB JACK						

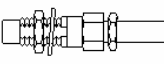
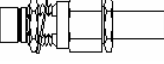
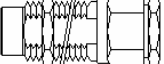
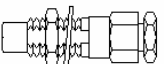
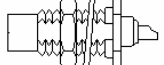

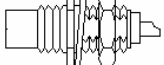
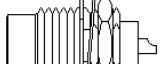
In addition to our Standard SMB offering, Microwave Components offers a variety of Mil-Approved (QPL) versions in accordance with M39012/67 thru M39012/71.

Contact our Sales Department for Price & Delivery at 1-800-282-4771 or email us at admin@microwavecomponentsinc.com

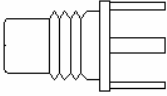
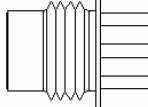
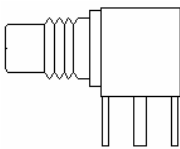
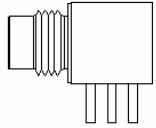
SMC Series

	MODEL#	DESCRIPTION / CABLE TYPE	1-24	25-49	50-99	100+
	MC5003	50 OHM CRIMP/CLAMP / RG174,188,316	7.50	6.00	5.75	5.45
	MC5004	50 OHM CRIMP/CLAMP / RG178,196	7.50	6.00	5.75	5.45
	MC5110	50 OHM CRIMP/CLAMP / RD316	7.50	6.00	5.75	5.00
PLUG						
	MODEL#	DESCRIPTION / CABLE TYPE	1-24	25-49	50-99	100+
	MC5007	75 OHM CRIMP/CLAMP / RG179	9.95	9.25	8.55	7.95
	MC5008	75 OHM CRIMP/CLAMP / RG180,195	9.95	9.25	8.55	7.95
PLUG						
	MODEL#	DESCRIPTION / CABLE TYPE	1-24	25-49	50-99	100+
	MC5012	50 OHM CLAMP / RG174,188,316	6.95	6.45	5.95	5.55
	MC5013	50 OHM CLAMP / RG178,196	6.95	6.45	5.95	5.55
	MC5014	50 OHM SOLDER/CLAMP / RG402	11.10	8.90	7.95	6.95
	MC5112	50 OHM SOLDER /CLAMP / RG405	11.10	8.90	7.95	6.95
PLUG						
	MODEL#	DESCRIPTION / CABLE TYPE	1-24	25-49	50-99	100+
	MC5017	75 OHM CLAMP / RG180,195	8.95	7.85	7.00	6.35
	MC5018	75 OHM CLAMP / RG179	8.95	7.85	7.00	6.35
PLUG						
	MODEL#	DESCRIPTION / CABLE TYPE	1-24	25-49	50-99	100+
	MC5021	50 OHM CRIMP / RG174,188,316	13.05	10.50	9.30	8.15
	MC5022	50 OHM CRIMP / RG178,196	13.05	10.50	9.30	8.15
	MC5114	50 OHM CRIMP / RD316	13.05	10.50	9.30	8.15
RIGHT-ANGLE PLUG						
	MODEL#	DESCRIPTION / CABLE TYPE	1-24	25-49	50-99	100+
	MC5025	75 OHM CRIMP / RG179	18.65	15.85	14.10	12.35
RIGHT-ANGLE PLUG						
	MODEL#	DESCRIPTION / CABLE TYPE	1-24	25-49	50-99	100+
	MC5035	75 OHM CLAMP / RG179	18.65	15.85	14.10	12.35
	MC5036	75 OHM CLAMP / RG180,195	18.65	15.85	14.10	12.35
RIGHT-ANGLE PLUG						
	MODEL#	DESCRIPTION / CABLE TYPE	1-24	25-49	50-99	100+
	MC5030	50 OHM CLAMP / RG174,188,316	9.70	8.75	7.80	6.95
	MC5031	50 OHM CLAMP / RG178,196	9.70	8.75	7.80	6.95
	MC5117	50 OHM CLAMP / RD316	9.70	8.75	7.80	6.95
	MC5118	50 OHM SOLDER/CLAMP / RG402	12.65	10.75	9.55	8.35
	MC5032	50 OHM SOLDER/CLAMP / RG405	12.65	10.75	9.55	8.35
RIGHT-ANGLE PLUG						

SMC Series

 BULKHEAD JACK	MODEL#	DESCRIPTION / CABLE TYPE	1-24	25-49	50-99	100+
	MC5039	50 OHM CRIMP/CLAMP / RG174,188,316	7.95	7.35	6.85	6.35
	MC5040	50 OHM CRIMP/CLAMP / RG178,196	7.95	7.35	6.85	6.35
	MC5120	50 OHM CRIMP/CLAMP / RD316	7.95	7.35	6.85	6.35
USE MOUNTING #68						
 BULKHEAD JACK	MODEL#	DESCRIPTION / CABLE TYPE	1-24	25-49	50-99	100+
	MC5043	75 OHM CRIMP/CLAMP / RG179	16.45	15.25	14.10	13.25
	MC5044	75 OHM CRIMP/CLAMP / RG180,195	16.45	15.25	14.10	13.25
	USE MOUNTING #97					
 BULKHEAD JACK	MODEL#	DESCRIPTION / CABLE TYPE	1-24	25-49	50-99	100+
	MC5053	75 OHM CLAMP / RG179	16.45	15.25	12.00	11.15
USE MOUNTING #97						
 BULKHEAD JACK	MODEL#	DESCRIPTION / CABLE TYPE	1-24	25-49	50-99	100+
	MC5048	50 OHM CLAMP / RG174,188,316	7.95	7.35	6.85	6.35
	MC5049	50 OHM CLAMP / RG178,196	7.95	7.35	6.85	6.35
	MC5122	50 OHM SOLDER CLAMP / RG402	7.95	7.35	6.85	6.35
	MC5050	50 OHM SOLDER CLAMP / RG405	7.95	7.35	6.85	6.35
USE MOUNTING #68						
 JACK RECEPTACLE	MODEL#	DESCRIPTION	1-24	25-49	50-99	100+
	MC5056	50 OHM SOLDER CUP REAR MOUNT	4.00	3.70	3.40	3.20
USE MOUNTING #68						
 JACK RECEPTACLE	MODEL#	DESCRIPTION	1-24	25-49	50-99	100+
	MC5058	75 OHM SOLDER CUP REAR MOUNT	10.35	9.65	8.45	7.50
USE MOUNTING #97						
 JACK RECEPTACLE	MODEL#	DESCRIPTION	1-24	25-49	50-99	100+
	MC5060	50 OHM SOLDER CUP FRONT MOUNT	4.00	3.70	3.40	3.20
USE MOUNTING #68						
 JACK RECEPTACLE	MODEL#	DESCRIPTION	1-24	25-49	50-99	100+
	MC5062	75 OHM SOLDER CUP FRONT MOUNT	10.35	9.65	8.45	7.50
USE MOUNTING #97						


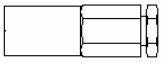
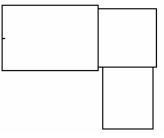
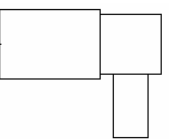
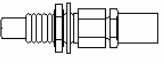
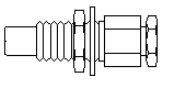
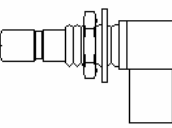
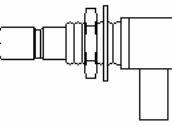
SMC Series

	<u>MODEL#</u> MC5068	<u>DESCRIPTION / CABLE TYPE</u> 50 OHM JACK, PCB USE MOUNTING #PCB06	<u>1-24</u> 4.85	<u>25-49</u> 4.25	<u>50-99</u> 3.70	<u>100+</u> 3.50
PCB JACK						
	<u>MODEL#</u> MC5070	<u>DESCRIPTION</u> 75 OHM JACK, PCB USE MOUNTING #PCB06	<u>1-24</u> 5.50	<u>25-49</u> 4.85	<u>50-99</u> 4.30	<u>100+</u> 4.20
PCB JACK						
	<u>MODEL#</u> MC5072	<u>DESCRIPTION</u> 50 OHM R/A JACK, PCB USE MOUNTING #PCB06	<u>1-24</u> 9.95	<u>25-49</u> 8.50	<u>50-99</u> 7.40	<u>100+</u> 6.30
RIGHT-ANGLE PCB JACK						
	<u>MODEL#</u> MC5074	<u>DESCRIPTION</u> 75 OHM R/A JACK, PCB USE MOUNTING #PCB06	<u>1-24</u> 12.60	<u>25-49</u> 11.40	<u>50-99</u> 10.15	<u>100+</u> 8.85
RIGHT-ANGLE PCB JACK						

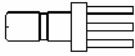
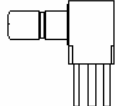
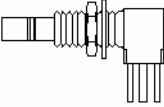
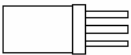
In addition to our Standard SMC offering, Microwave Components offers a variety of Mil-Approved (QPL) versions in accordance with M39012/73 thru M39012/77.

Contact our Sales Department for Price & Delivery at 1-800-282-4771 or email us at admin@microwavecomponentsinc.com

SSMB Series

	MODEL#	DESCRIPTION / CABLE TYPE	1-24	25-49	50-99	100+
	MC5157	CRIMP/CLAMP / RG178,196	21.15	17.65	14.10	11.75
	MC5158	CRIMP/CLAMP / RG174,188,316	21.15	17.65	14.10	11.75
PLUG						
	MODEL#	DESCRIPTION / CABLE TYPE	1-24	25-49	50-99	100+
	MC5159	SOLDER/CLAMP / RG405	21.15	17.65	14.10	11.75
	MC5160	SOLDER/CLAMP / .047 SEMI-RIGID	21.15	17.65	14.10	11.75
	MODEL#	DESCRIPTION / CABLE TYPE	1-24	25-49	50-99	100+
	MC5161	CRIMP / RG178,196	19.30	15.44	12.35	10.45
	MC5162	CRIMP / RG174,188,316	19.30	15.44	12.35	10.45
RIGHT-ANGLE PLUG						
	MODEL#	DESCRIPTION / CABLE TYPE	1-24	25-49	50-99	100+
	MC5163	DIRECT SOLDER / RG405	19.30	15.44	12.35	10.45
	MC5164	DIRECT SOLDER / .047 SEMI-RIGID	19.30	15.44	12.35	10.45
RIGHT-ANGLE PLUG						
	MODEL#	DESCRIPTION / CABLE TYPE	1-24	25-49	50-99	100+
	MC5165	CRIMP/CLAMP / RG178,196	19.30	15.44	12.35	10.45
	MC5166	CRIMP/CLAMP / RG174,188,316 USE MOUNTING #98	19.30	15.44	12.35	10.45
BULKHEAD JACK						
	MODEL#	DESCRIPTION / CABLE TYPE	1-24	25-49	50-99	100+
	MC5167	SOLDER/CLAMP / RG405	19.30	15.44	12.35	10.45
	MC5168	SOLDER/CLAMP / .047 SEMI-RIGID USE MOUNTING #98	19.30	15.44	12.35	10.45
BULKHEAD JACK						
	MODEL#	DESCRIPTION / CABLE TYPE	1-24	25-49	50-99	100+
	MC5169	CRIMP / RG178,196	13.00	12.30	10.80	9.60
	MC5170	CRIMP / RG174,188,316 USE MOUNTING #98	13.00	12.30	10.80	9.60
RIGHT-ANGLE BULKHEAD JACK						
	MODEL#	DESCRIPTION / CABLE TYPE	1-24	25-49	50-99	100+
	MC5171	DIRECT SOLDER / RG405	13.00	12.30	10.80	9.60
	MC5172	DIRECT SOLDER / .047 SEMI-RIGID USE MOUNTING #98	13.00	12.30	10.80	9.60
BULKHEAD JACK						



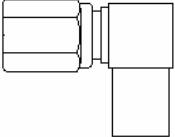
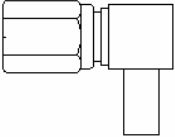

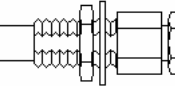
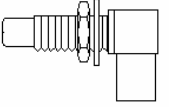
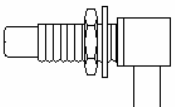
SSMB Series

	<u>MODEL#</u> MC5173	<u>DESCRIPTION</u> PCB JACK USE MOUNTING #PCB09	<u>1-24</u> 6.95	<u>25-49</u> 6.45	<u>50-99</u> 5.95	<u>100+</u> 5.50
PCB JACK						
	<u>MODEL#</u> MC5174	<u>DESCRIPTION</u> PCB R/A JACK USE MOUNTING #PCB09	<u>1-24</u> 15.25	<u>25-49</u> 13.00	<u>50-99</u> 11.30	<u>100+</u> 9.85
PCB JACK RIGHT-ANGLE						
	<u>MODEL#</u> MC5175	<u>DESCRIPTION</u> PCB BULKHEAD JACK R/A USE MOUNTING #PCB09	<u>1-24</u> 15.25	<u>25-49</u> 13.00	<u>50-99</u> 11.30	<u>100+</u> 9.85
RIGHT-ANGLE PCB BULKHEAD JACK						
	<u>MODEL#</u> MC5176	<u>DESCRIPTION</u> PCB PLUG USE MOUNTING #BCB09	<u>1-24</u> 12.50	<u>25-49</u> 10.65	<u>50-99</u> 9.25	<u>100+</u> 8.10
PCB PLUG						

Microwave Components offers the industry the broadest range of Mil-Approved (QPL) Connectors in accordance with Mil-PRF-39012 and Adapters in accordance with Mil-PRF-55339. A large variety of configurations in Type N, TNC, BNC, SMA, SMB, and SMC are readily available from stock.

Contact our Sales Department for Price & Delivery at 1-800-282-4771 or email us at admin@microwavecomponentsinc.com

SSMC Series

	MODEL#	DESCRIPTION / CABLE TYPE	1-24	25-49	50-99	100+
	MC5177	CRIMP/CLAMP / RG178,196	20.35	17.30	14.70	12.50
	MC5178	CRIMP/CLAMP / RG174,188,316	20.35	17.30	14.70	12.50
PLUG						
	MODEL#	DESCRIPTION / CABLE TYPE	1-24	25-49	50-99	100+
	MC5179	SOLDER/CLAMP / RG405	20.35	17.30	14.70	12.50
	MC5180	SOLDER/CLAMP / .047 SEMI-RIGID	20.35	17.30	14.70	12.50
PLUG						
	MODEL#	DESCRIPTION / CABLE TYPE	1-24	25-49	50-99	100+
	MC5181	CRIMP / RG178,196	19.30	15.44	12.35	10.45
	MC5182	CRIMP / RG174,188,316	19.30	15.44	12.35	10.45
RIGHT-ANGLE PLUG						
	MODEL#	DESCRIPTION / CABLE TYPE	1-24	25-49	50-99	100+
	MC5183	DIRECT SOLDER / RG405	19.30	15.44	12.35	10.45
	MC5184	DIRECT SOLDER / .047 SEMI-RIGID	19.30	15.44	12.35	10.45
RIGHT-ANGLE PLUG						
	MODEL#	DESCRIPTION	1-24	25-49	50-99	100+
	MC5185	CRIMP/CLAMP / RG178,196	15.95	13.30	11.35	9.60
	MC5186	CRIMP/CLAMP / RG174,188,316 USE MOUNTING #98	15.95	13.30	11.35	9.60
BULKHEAD JACK						
	MODEL#	DESCRIPTION	1-24	25-49	50-99	100+
	MC5187	SOLDER/CLAMP / RG405	15.95	13.30	11.35	9.60
	MC5188	SOLDER/CLAMP / .047 SEMI-RIGID USE MOUNTING #98	15.95	13.30	11.35	9.60
BULKHEAD JACK						
	MODEL#	DESCRIPTION	1-24	25-49	50-99	100+
	MC5189	CRIMP / RG178,196	39.95	33.50	31.00	27.00
	MC5190	CRIMP / RG174,188,316 USE MOUNTING #98	39.95	33.50	31.00	27.00
RIGHT-ANGLE BULKHEAD JACK						
	MODEL#	DESCRIPTION	1-24	25-49	50-99	100+
	MC5191	DIRECT SOLDER / RG405	39.95	33.50	31.00	27.00
	MC5192	DIRECT SOLDER / .047 SEMI-RIGID USE MOUNTING #98	39.95	33.50	31.00	27.00
RIGHT-ANGLE BULKHEAD JACK						

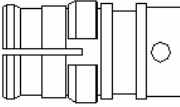
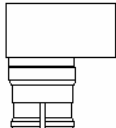
SSMC Series

	<u>MODEL#</u> MC5193	<u>DESCRIPTION</u> PCB JACK USE MOUNTING #PCB09	<u>1-24</u> 10.65	<u>25-49</u> 8.15	<u>50-99</u> 7.10	<u>100+</u> 7.35
PCB JACK						
	<u>MODEL#</u> MC5194	<u>DESCRIPTION</u> PCB R/A JACK USE MOUNTING #PCB09	<u>1-24</u> 15.95	<u>25-49</u> 13.60	<u>50-99</u> 12.95	<u>100+</u> 10.95
PCB JACK RIGHT-ANGLE						
	<u>MODEL#</u> MC5195	<u>DESCRIPTION</u> PCB BULKHEAD JACK R/A USE MOUNTING #PCB09	<u>1-24</u> 22.95	<u>25-49</u> 20.95	<u>50-99</u> 17.95	<u>100+</u> 15.95
RIGHT-ANGLE PCB BULKHEAD JACK						
	<u>MODEL#</u> MC5196	<u>DESCRIPTION</u> BULKHEAD JACK RECEPTACLE USE MOUNTING #98	<u>1-24</u> 17.25	<u>25-49</u> 15.50	<u>50-99</u> 14.65	<u>100+</u> 13.30
PCB JACK						

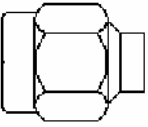
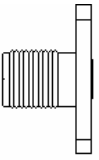
Microwave Components offers the industry the broadest range of Mil-Approved (QPL) Connectors in accordance with Mil-PRF-39012 and Adapters in accordance with Mil-PRF-55339. A large variety of configurations in Type N, TNC, BNC, SMA, SMB, and SMC are readily available from stock.

Contact our Sales Department for Price & Delivery at 1-800-282-4771 or email us at admin@microwavecomponentsinc.com


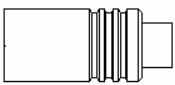
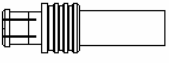
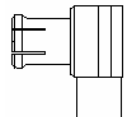
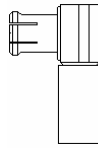
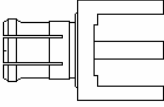
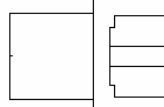
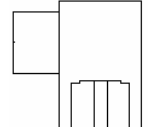
SMP Series

	<u>MODEL#</u>	<u>DESCRIPTION / CABLE TYPE</u>	<u>1-24</u>	<u>25-49</u>	<u>50-99</u>	<u>100+</u>
	MC8008	JACK DIRECT SOLDER / RG405	17.45	15.40	13.45	11.95
SMP JACK						
	<u>MODEL#</u>	<u>DESCRIPTION / CABLE TYPE</u>	<u>1-24</u>	<u>25-49</u>	<u>50-99</u>	<u>100+</u>
	MC8009	R/A JACK DIRECT SOLDER / RG405	18.40	16.95	14.85	13.25
SMP JACK RIGHT-ANGLE						

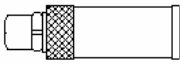
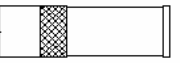
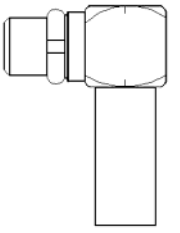
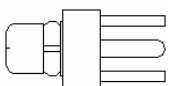

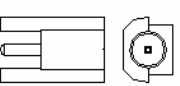
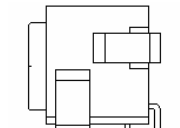
2.9MM Series

	<u>MODEL#</u>	<u>DESCRIPTION / CABLE TYPE</u>	<u>1-24</u>	<u>25-49</u>	<u>50-99</u>	<u>100+</u>
	MC8010	PLUG DIRECT SOLDER / RG402	36.35	30.90	24.90	21.35
	MC8011	PLUG DIRECT SOLDER / RG405	25.60	23.00	15.70	13.50
	MC8012	PLUG DIRECT SOLDER / RG405 LOW LOSS	25.60	23.00	15.70	13.50
2.9MM PLUG						
	<u>MODEL#</u>	<u>DESCRIPTION / CABLE TYPE</u>	<u>1-24</u>	<u>25-49</u>	<u>50-99</u>	<u>100+</u>
	MC8013	4-HOLE PANEL JACK / ACCEPT .012 PIN USE MOUNTING #92	28.35	26.35	25.30	24.45
2.9MM 4-HOLE PANEL JACK						

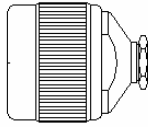
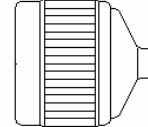
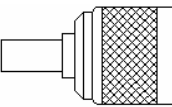
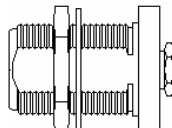
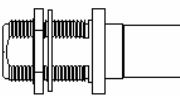
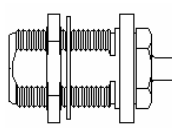
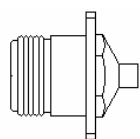
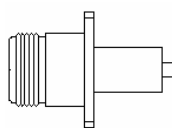
MCX Series

	MODEL#	DESCRIPTION / CABLE TYPE	1-24	25-49	50-99	100+
	MC5124	DIRECT SOLDER PLUG / RG405	4.95	4.05	3.30	2.55
	MC5125	DIRECT SOLDER PLUG / .047 SEMI-RIGID	5.00	4.25	3.80	3.55
PLUG						
	MODEL#	DESCRIPTION / CABLE TYPE	1-24	25-49	50-99	100+
	MC5126	DIRECT SOLDER JACK / RG405	4.95	4.05	3.30	2.55
	MC5127	DIRECT SOLDER JACK / .047 SEMI-RIGID	6.70	4.75	3.80	3.55
JACK						
	MODEL#	DESCRIPTION / CABLE TYPE	1-24	25-49	50-99	100+
	MC5128	CRIMP PLUG / RG178,196	4.25	3.60	3.05	2.90
	MC5129	CRIMP PLUG / RG174,188,316	4.25	3.60	3.05	2.90
	MC5130	CRIMP PLUG / RD316	4.25	3.60	3.05	2.90
PLUG						
	MODEL#	DESCRIPTION / CABLE TYPE	1-24	25-49	50-99	100+
	MC5131	R/A DIRECT SOLDER PLUG / RG402	6.10	5.75	3.75	3.25
	MC5132	R/A DIRECT SOLDER PLUG / RG405	4.50	4.05	3.55	3.00
	MC5133	R/A DIRECT SOLDER PLUG / .047 SRC	6.20	5.75	3.75	3.25
RIGHT-ANGLE PLUG						
	MODEL#	DESCRIPTION / CABLE TYPE	1-24	25-49	50-99	100+
	MC5134	R/A CRIMP PLUG / RG178,196	4.25	3.60	3.05	2.90
	MC5135	R/A CRIMP PLUG / RG188,316,179,187	4.25	3.60	3.05	2.90
	MC5136	R/A CRIMP PLUG / RD316	4.25	3.60	3.05	2.90
RIGHT-ANGLE PLUG						
	MODEL#	DESCRIPTION	1-24	25-49	50-99	100+
	MC5137	STRAIGHT PCB PLUG .155 LEG LENGTH USE MOUNTING #PCB06	4.25	4.10	3.90	3.75
PCB PLUG						
	MODEL#	DESCRIPTION	1-24	25-49	50-99	100+
	MC5138	STRAIGHT PCB JACK .155 LEG LENGTH USE MOUNTING #PCB06	3.30	2.56	2.40	2.25
PCB JACK						
	MODEL#	DESCRIPTION	1-24	25-49	50-99	100+
	MC5139	R/A PCB JACK .155 LEG LENGTH USE MOUNTING #PCB06	5.90	5.60	4.90	4.15
RIGHT-ANGLE PCB JACK						

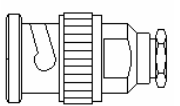
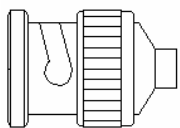
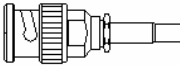
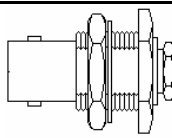
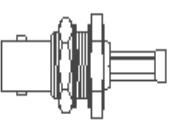
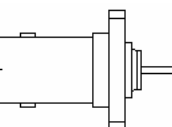
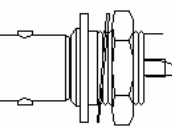
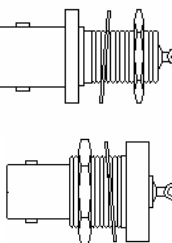
MMCX Series

 PLUG	MODEL#	DESCRIPTION / CABLE TYPE	1-24	25-49	50-99	100+
	MC5140	CRIMP PLUG / RG178,196	4.40	4.15	4.05	3.90
	MC5141	CRIMP PLUG / RG174,188,316	4.40	4.15	4.05	3.90
	MC5142	CRIMP PLUG / RD316	6.85	6.40	6.15	5.95
	MC5143	DIRECT SOLDER PLUG / RG405	5.10	4.80	4.65	4.50
	MC5144	DIRECT SOLDER PLUG / .047 SRC	6.85	6.40	6.15	5.95
 JACK	MODEL#	DESCRIPTION / CABLE TYPE	1-24	25-49	50-99	100+
	MC5145	CRIMP JACK / RG178,196	6.25	5.85	5.45	5.00
	MC5146	CRIMP JACK / RG174,188,316	6.25	5.85	5.45	5.00
 RIGHT-ANGLE PLUG	MODEL#	DESCRIPTION / CABLE TYPE	1-24	25-49	50-99	100+
	MC5147	R/A CRIMP PLUG / RG178,196	4.95	4.50	4.35	4.15
	MC5148	R/A CRIMP PLUG / RD174,188,316	4.95	4.50	4.35	4.15
	MC5149	R/A CRIMP PLUG / RD178	4.95	4.50	4.35	4.15
	MC5150	R/A CRIMP PLUG / RD316	4.95	4.50	4.35	4.15
	MC5151	R/A DIRECT SOLDER PLUG / RG405	4.95	4.50	4.35	4.15
	MC5152	R/A DIRECT SOLDER PLUG / .047 SRC	6.60	6.15	5.95	5.80
 PCB PLUG	MODEL#	DESCRIPTION / CABLE TYPE	1-24	25-49	50-99	100+
	MC5153	PCB PLUG USE MOUNTING #PCB08	4.95	4.65	4.55	4.40
 PCB JACK	MODEL#	DESCRIPTION / CABLE TYPE	1-24	25-49	50-99	100+
	MC5154	PCB JACK USE MOUNTING #PCB08	3.95	3.75	3.60	3.55
 EDGE MOUNT PCB JACK	MODEL#	DESCRIPTION / CABLE TYPE	1-24	25-49	50-99	100+
	MC5155	END LAUNCH PCB JACK	4.95	4.45	4.00	3.95
 RIGHT-ANGLE PCB JACK	MODEL#	DESCRIPTION / CABLE TYPE	1-24	25-49	50-99	100+
	MC5156	R/A PCB JACK USE MOUNTING #PCB08	5.85	5.60	5.10	4.60

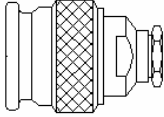
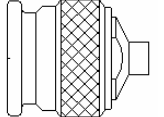
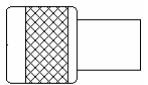
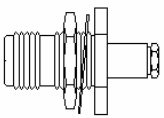
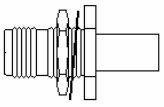
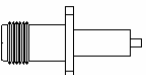
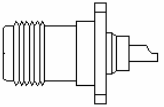
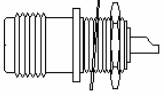
Type N Series

	MODEL#	DESCRIPTION / CABLE TYPE	1-24	25-49	50-99	100+
	MC3001	CLAMP / RG55, 58, 141, 142, 223	6.60	5.45	4.90	4.15
	MC3002	CLAMP / RG8, 9, 213, 214	6.60	5.45	4.90	4.15
	MC3004	CLAMP / RG174, 188, 316	26.40	23.75	21.35	18.95
PLUG						
	MODEL#	DESCRIPTION / CABLE TYPE	1-24	25-49	50-99	100+
	MC3010	DIRECT SOLDER / .141 SEMI-RIGID	15.20	14.25	13.50	12.80
	MC3030	DIRECT SOLDER / .085 SEMI-RIGID	27.20	24.75	22.25	21.30
PLUG						
	MODEL#	DESCRIPTION / CABLE TYPE	1-24	25-49	50-99	100+
	MC3005	CRIMP / RG55,141,303,	5.40	4.60	3.60	2.60
	MC3006	CRIMP / RG55,142,223,400	5.40	4.90	4.50	4.00
	MC3008	CRIMP / RG9,214	7.60	7.40	6.95	6.60
	MC3009	CRIMP / RG174,188,316	26.40	23.75	21.35	18.95
PLUG						
	MODEL#	DESCRIPTION / CABLE TYPE	1-24	25-49	50-99	100+
	MC3011	CLAMP / RG55, RG58, 141, 142, 223, 303, 400	17.85	16.50	15.45	14.50
	MC3012	CLAMP / RG8, 9, 213, 214	26.10	22.35	17.25	14.65
	MC3013	CLAMP / RG174, 188, 316 USE MOUNTING #72				
BULKHEAD JACK						
	MODEL#	DESCRIPTION / CABLE TYPE	1-24	25-49	50-99	100+
	MC3014	CRIMP / RG55, 142, 223, 400	9.95	9.25	8.55	7.95
	MC3015	CRIMP / RG8, 213	13.95	12.95	12.00	11.05
	MC3016	CRIMP / RG9, 214	13.95	12.95	12.00	11.05
	MC3017	CRIMP / RG174, 188, 316 USE MOUNTING #72	26.40	23.75	21.35	18.95
BULKHEAD JACK						
	MODEL#	DESCRIPTION / CABLE TYPE	1-24	25-49	50-99	100+
	MC3018	BULKHEAD JACK, SOLDER/CLAMP/ RG402	19.00	17.95	13.95	10.50
	MC3045	PRECISION BULKHEAD JACK, SOLDER /CLAMP/ RG402	39.60	37.95	34.00	28.32
	MC3046	BULKHEAD JACK, SOLDER/CLAMP/ RG405 USE MOUNTING #72	35.75	29.10	25.45	22.65
BULKHEAD JACK						
	MODEL#	DESCRIPTION / CABLE TYPE	1-24	25-49	50-99	100+
	MC3033	SOLDER/CLAMP / RG402	39.60	35.05	30.75	27.25
	MC3037	SOLDER/CLAMP / RG405 USE MOUNTING #33	47.25	41.80	36.60	32.55
4-HOLE PANEL JACK						
	MODEL#	DESCRIPTION / CABLE TYPE	1-24	25-49	50-99	100+
	MC3021	.590 TEFLON & CONTACT PROBE	15.05	14.25	13.15	11.85
	MC3069	.590 TEFLON & CONTACT PROBE 18GHz	31.85	27.20	24.50	20.05
	MC3023	SOLDER CUP CONTACT — NO TEFLON USE MOUNTING #33	4.95	4.60	4.25	3.95
4-HOLE PANEL JACK						

BNC Series

	MODEL#	DESCRIPTION / CABLE TYPE	1-24	25-49	50-99	100+
	MC4001	PLUG CLAMP / RG55,58,141,142,223,303,400	3.50	3.25	3.00	2.80
	MC4002	PLUG CLAMP / RG59,62	3.50	3.25	3.00	2.80
	MC4003	PLUG CLAMP / RG174,188,316	7.75	6.60	5.60	4.75
PLUG						
	MODEL#	DESCRIPTION / CABLE TYPE	1-24	25-49	50-99	100+
	MC4004	PLUG DIRECT SOLDER / RG402	3.50	3.25	3.00	2.80
	MC4043	PLUG DIRECT SOLDER / RG405	3.50	3.25	3.00	2.80
PLUG						
	MODEL#	DESCRIPTION / CABLE TYPE	1-24	25-49	50-99	100+
	MC4005	PLUG CRIMP / RG58,141,303	7.15	6.05	5.15	4.40
	MC4006	PLUG CRIMP / RG55,142,223,400	4.10	3.50	3.25	3.10
	MC4007	PLUG CRIMP / RG59,62	3.50	3.25	3.00	2.80
	MC4008	PLUG CRIMP / RG174,188,316	3.50	3.25	3.00	2.80
	MC4031	PLUG CRIMP / RD316	7.75	6.20	4.95	2.97
PLUG						
	MODEL#	DESCRIPTION / CABLE TYPE	1-24	25-49	50-99	100+
	MC4011	JACK CLAMP / RG55,58,141,142,223,303,400	16.25	13.75	11.70	9.95
	MC4012	JACK CLAMP / RG59,62	16.25	13.75	11.70	9.95
	MC4013	JACK CLAMP / RG174,188,316 USE MOUNTING #59	19.95	17.85	16.05	13.65
BULKHEAD JACK						
	MODEL#	DESCRIPTION / CABLE TYPE	1-24	25-49	50-99	100+
	MC4014	JACK CRIMP / RG58,142,223,400	4.10	3.50	3.25	3.10
	MC4015	JACK CRIMP / RG55,141,303	4.10	3.50	3.25	3.10
	MC4016	JACK,CRIMP / RG59,62	4.10	3.50	3.25	3.10
	MC4017	JACK,CRIMP / RG174,188,316 USE MOUNTING #59	4.10	3.50	3.25	3.10
BULKHEAD JACK						
	MODEL#	DESCRIPTION / CABLE TYPE	1-24	25-49	50-99	100+
	MC4021	SOLDER CUP, CLEARANCE HOLES (MOUNTING#09)	4.95	3.95	3.25	2.75
	MC4044	SOLDER CUP, TAP HOLES (MOUNTING#07)	6.95	5.75	5.00	4.50
4-HOLE PANEL JACK						
	MODEL#	DESCRIPTION / CABLE TYPE	1-24	25-49	50-99	100+
	MC4022	SOLDER CUP, ISOLATED GROUND (MOUNTING #59)	5.25	4.75	4.25	3.95
	MC4045	BULKHEAD JACK, SLD/POT (MOUNTING #75)	3.95	3.70	3.40	3.15
	MC4046	BULKHEAD JACK, SLD/POT (MOUNTING #62)	10.95	7.30	5.60	4.85
	MC4047	BULKHEAD JACK, SLD/POT (MOUNTING #75)	10.95	7.30	5.60	4.85
BULKHEAD JACK						
	MODEL#	DESCRIPTION / CABLE TYPE	1-24	25-49	50-99	100+
	MC4023	BULKHEAD JACK, HERMETIC (MOUNTING#63)	16.15	14.45	12.45	10.75
	MC4024	BULKHEAD JACK, HERMETIC (MOUNTING #59)	16.15	14.45	12.05	10.25

TNC Series

	MODEL#	DESCRIPTION / CABLE TYPE	1-24	25-49	50-99	100+
	MC6014	PLUG CLAMP / RG58,141,142,223,303,400	12.50	11.35	10.60	9.85
	MC6015	PLUG CLAMP / RG174,188,316	12.50	11.35	10.60	9.85
	MODEL#	DESCRIPTION / CABLE TYPE	1-24	25-49	50-99	100+
	MC6016	PLUG DIRECT SOLDER / RG402	20.90	18.85	16.95	14.95
	MC6017	PLUG DIRECT SOLDER / RG405	20.90	18.85	16.95	14.95
	MODEL#	DESCRIPTION / CABLE TYPE	1-24	25-49	50-99	100+
	MC6018	PLUG CRIMP / RG58,141,303	7.75	7.10	6.60	6.20
	MC6019	PLUG CRIMP / RG142,223,400	7.75	7.10	6.60	6.20
	MC6020	PLUG CRIMP / RG174,188,316	12.15	11.30	10.50	9.90
	MC6021	PLUG CRIMP / RD316	12.15	11.30	10.50	9.90
	MC6022	REVERSE POLARITY PLUG, CRIMP / RG58, 141, 303	4.80	3.90	3.30	2.95
	MC6023	REVERSE POLARITY PLUG, CRIMP / RG142,223,400	4.80	3.90	3.30	2.95
	MC6024	REVERSE POLARITY PLUG, CRIMP / RG174,188,316	4.80	3.90	3.30	2.95
	MODEL#	DESCRIPTION / CABLE TYPE	1-24	25-49	50-99	100+
	MC6025	BLKD JACK CLAMP / RG58,141,142,203,303,400	23.65	22.95	21.95	19.35
	MC6026	BLKD JACK CLAMP / RG174,188,316	23.20	21.95	19.85	16.55
	MODEL#	DESCRIPTION / CABLE TYPE	1-24	25-49	50-99	100+
	MC6027	BLKD JACK CRIMP / RG58,141,303	15.90	14.30	13.90	13.00
	MC6028	BLKD JACK CRIMP / RG142,223,400	14.85	13.40	12.75	10.60
	MC6029	BLKD JACK CRIMP / RG174,188,316	12.70	11.80	11.10	10.35
	MC6030	BLKD JACK CRIMP / RD316	12.70	11.80	11.10	10.35
	MC6031	BLKD JACK REVERSE POLARITY CRIMP /RG58,141,303	6.25	4.95	3.80	3.00
	MC6032	BLKD JACK REVERSE POLARITY CRIMP /RG142,223,400	6.25	4.95	3.80	3.00
	MC6033	BLKD JACK REVERSE POLIARTY CRIMP /RG174,188,316	6.25	4.95	3.80	3.00
	MODEL#	DESCRIPTION / CABLE TYPE	1-24	25-49	50-99	100+
	MC6034	WITH .590 TEFLON & CONTACT PROBE USE MOUNTING #97	19.25	17.25	15.50	13.95
4-HOLE PANEL JACK						
	MODEL#	DESCRIPTION	1-24	25-49	50-99	100+
	MC6035	SOLDER CUP USE MOUNTING #09	6.95	6.45	5.95	5.50
BULKHEAD JACK						
	MODEL#	DESCRIPTION / CABLE TYPE	1-24	25-49	50-99	100+
	MC6036	TNC BKHD RECEPTACLE, FRONT MOUNT USE MOUNTING #62	10.25	8.05	7.20	6.50
BULKHEAD JACK						

ADAPTER CROSS-REFERENCE GUIDE

INTERFACE TO	INTERFACE	PART #	PAGE	
2.4MM JACK	2.4MM JACK	MC2154	32	
	2.4MM PLUG	MC2156	32	
	2.4MM R/A PLUG	MC2157	32	
	2.9MM JACK	MC1195	37	
	2.9MM PLUG	MC1196	37	
	3.5MM JACK	MC1197	37	
	3.5MM PLUG	MC1198	37	
	SMA JACK	MC1199	37	
	SMA PLUG	MC1200	37	
	SSMA PLUG	MC1201	37	
	2.4MM PLUG	2.4MM PLUG	MC2155	32
		2.4MM JACK	MC2156	32
		2.4MM R/A JACK	MC2157	32
		2.9MM JACK	MC1202	37
2.9MM PLUG		MC1203	38	
3.5MM JACK		MC1204	38	
3.5MM PLUG		MC1205	38	
7MM		MC1206	38	
SMA JACK		MC1207	38	
SMA PLUG		MC1208	38	
SSMA PLUG		MC1209	38	
2.9MM JACK	2.4MM JACK	MC1195	37	
	2.4MM PLUG	MC1202	37	
	2.9MM JACK	MC2145	30	
	2.9MM BLKHD JACK	MC2146	31	
	2.9MM PLUG	MC2147	31	
	3.5MM JACK	MC1210	38	
	3.5MM PLUG	MC1211	39	
	7MM	MC1212	39	
2.9MM PLUG	2.4MM JACK	MC1196	37	
	2.4MM PLUG	MC1203	38	
	2.9MM JACK	MC2147	31	
	2.9MM PLUG	MC2148	31	
	3.5MM JACK	MC1213	39	
	3.5MM PLUG	MC1214	39	
	7MM	MC1215	39	
3.5MM JACK	2.4MM JACK	MC1197	37	
	2.4MM PLUG	MC1204	38	
	2.9MM JACK	MC1210	38	
	2.9MM PLUG	MC1213	39	
	3.5MM JACK	MC2149	31	
	3.5MM BLKHD JACK	MC2150	31	
	3.5MM PANEL JACK	MC2153	31	
	3.5MM PLUG	MC2151	31	
	7MM	MC1188	39	
	N JACK	MC1189	39	
	N PLUG	MC1190	39	
	SMA JACK	MC1191	40	
	3.5MM PLUG	2.4MM JACK	MC1198	37
		2.4MM PLUG	MC1205	38
2.9MM JACK		MC1211	39	
2.9MM PLUG		MC1214	39	
3.5MM JACK		MC2151	31	
3.5MM PLUG		MC2152	31	
7MM		MC1192	40	
N JACK		MC1193	40	
N PLUG	MC1194	40		
MMCX JACK	MMCX JACK	MC5197	27	
	SMA JACK	MC1178	46	
	SMA PLUG	MC1179	46	
MMCX PLUG	SMA JACK	MC1177	46	
	SMA PLUG	MC1180	46	
MCX JACK	MCX JACK	MC5198	27	
	SMA JACK	MC1181	46	
	SMA PLUG	MC1182	46	
MCX PLUG	MCX PLUG	MC5199	27	
	SMA JACK	MC1183	47	
	SMA PLUG	MC1184	47	
SSMB JACK	SSMB BLKHD JACK	MC5200	27	
	SMB JACK	MC5080	27	
SMB JACK	SMB BLKHD JACK	MC5084	27	
	SMA JACK	MC1007	47	
	SMA PLUG	MC1003	47	
	SMC PLUG	MC1186	47	
	BNC JACK	MC1027	48	
	N PLUG	MC1235	45	

INTERFACE TO	INTERFACE	PART #	PAGE	
SMB JACK	BNC PLUG	MC1028	49	
	SMB PLUG	MC5082	27	
SMB PLUG	SMA JACK	MC1005	47	
	SMA PLUG	MC1001	47	
	SMC PLUG	MC1187	47	
	BNC JACK	MC1025	48	
	BNC PLUG	MC1026	49	
	SMC JACK	SMC JACK	MC5081	28
		SMC BLKHD JACK	MC5085	28
		SMA JACK	MC1008	48
		SMA PLUG	MC1004	48
	SMC PLUG	BNC JACK	MC1032	48
		BNC PLUG	MC1033	49
N PLUG		MC1234	45	
SMC PLUG		MC5083	28	
SMA JACK		MC1006	48	
SMA PLUG		MC1002	48	
BNC JACK		MC1030	48	
BNC PLUG		MC1031	49	
SMB PLUG		MC1187	47	
SMB JACK		MC1186	47	
SMA JACK		SMA JACK	MC2054	28
	SMA JACK (LONG BARREL)	MC2203	28	
	SMA BULKHEAD JACK	MC2060	30	
	SMA BLKHD JACK HERMETIC	MC2059	30	
	SMA PANEL JACK	MC1322	29	
	SMA PLUG	MC2055	29	
	SMA R/A RAD PLUG	MC2083	30	
	SMA R/A PLUG	MC2057	29	
	SMA R/A JACK	MC2056	29	
	SMA QUICK MATE PLUG	MC2158	29	
	SMA PLUG QUICK RELEASE	MC2102	29	
	2.4MM JACK	MC1199	37	
	2.4MM PLUG	MC1207	38	
	3.5MM JACK	MC1191	40	
	7MM JACK	MC1153	44	
	BMA PLUG	MC1232	45	
	BMA JACK	MC1230	44	
BMA BLKHD JACK	MC1229	44		
BNC BULKHEAD JACK	MC1013	40		
BNC JACK	MC1011	41		
BNC PLUG	MC1012	42		
N BULKHEAD JACK	MC1023	42		
N BULKHEAD JACK 18GHZ	MC1223	42		
N JACK	MC1020	42		
N PANEL JACK	MC1022	46		
N PLUG	MC1021	45		
SMA PLUG	MMCX JACK	MC1178	46	
	MMCX PLUG	MC1177	46	
	MCX JACK	MC1181	46	
	MCX PLUG	MC1183	47	
	SMB JACK	MC1007	47	
	SMB PLUG	MC1005	47	
	SMC JACK	MC1008	48	
	SMC PLUG	MC1006	48	
	SMP JACK	MC1225	43	
	TNC JACK	MC1016	43	
	TNC PLUG	MC1017	43	
	TNC BULKHEAD JACK	MC1227	43	
	TNC PANEL JACK	MC1228	43	
	SMA JACK	MC2055	29	
	SMA PLUG	MC2053	29	
	SMA RIGHT-ANGLE JACK	MC2057	29	
	SMA RIGHT-ANGLE PLUG	MC2058	29	
SMA R/A RADIUS JACK	MC2083	30		
SMA R/A RADIUS PLUG	MC1320	30		
2.4MM JACK	MC1200	37		
2.4MM PLUG	MC1208	38		
7MM	MC1249	44		
BMA JACK	MC1231	45		
BMA PLUG	MC1233	45		
BNC JACK	MC1010	41		
BNC PLUG	MC1099	42		
N JACK	MC1019	42		
N PLUG	MC 1018	45		
MMCX JACK	MC1179	46		

ADAPTER CROSS-REFERENCE GUIDE

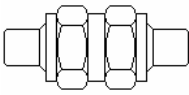
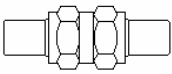
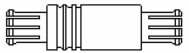
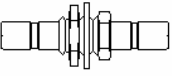
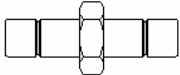
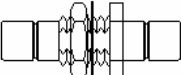
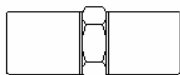
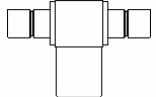
INTERFACE TO	INTERFACE	PART #	PAGE	
SMA PLUG	MMCX PLUG	MC1180	46	
	MCX JACK	MC1182	46	
	MCX PLUG	MC1184	47	
	SMB JACK	MC1003	47	
	SMB PLUG	MC1001	47	
	SMC JACK	MC1004	48	
	SMC PLUG	MC1002	48	
	SMP PLUG	MC1237	44	
	TNC JACK	MC1015	44	
	TNC PLUG	MC1014	44	
	TNC PANEL JACK	MC1238	44	
	SMP JACK	SMP JACK	MC5203	30
		SMA JACK	MC1225	43
	SMP PLUG	SMA PLUG	MC1237	44
	BNC JACK	BNC JACK	MC4026	32
		BNC BULKHEAD JACK	MC4027	32
		BNC BULKHEAD JACK HERM	MC4050	32
		BNC BLKHD JACK ISO/GRD	MC4028	33
		BNC PLUG	MC4051	33
		BNC RIGHT-ANGLE PLUG	MC4029	33
		F PLUG	MC1246	40
	N JACK	MC1218	40	
	N PLUG	MC1035	41	
	RCA PLUG	MC1247	49	
	SMA JACK	MC1011	41	
	SMA PLUG	MC1010	41	
	SMB JACK	MC1027	48	
	SMB PLUG	MC1025	48	
	SMC JACK	MC1032	48	
	SMC PLUG	MC1030	48	
	TNC PLUG	MC1039	41	
	TNC JACK	MC1037	41	
	UHF PLUG	MC1219	41	
BNC BLKH JACK	N JACK	MC1216	40	
	BNC JACK	MC4027	32	
BNC PLUG	BNC PLUG	MC4025	32	
	BNC JACK	MC4051	33	
	BNC RIGHT-ANGLE JACK	MC4029	33	
	F JACK	MC1220	41	
	UHF PLUG	MC1219	41	
	N JACK	MC1036	41	
	SMA JACK	MC1012	42	
	SMA PLUG	MC1099	42	
	SMB JACK	MC1028	49	
	SMB PLUG	MC1026	49	
	SMC JACK	MC1033	49	
	SMC PLUG	MC1031	49	
	RCA JACK	MC1248	49	
	TNC PLUG	MC1222	42	
	TNC JACK	MC1038	42	
N JACK	N JACK	MC3025	34	
	N BULKHEAD JACK	MC3026	35	
	N BULKHEAD JACK HERM	MC3048	35	
	N PLUG	MC3049	35	
	N PLUG QUICK RELEASE	MC3053	35	
	N RIGHT-ANGLE PLUG	MC3027	35	
	N R/A RADIUS PLUG	MC1321	35	
	3.5MM JACK	MC1189	39	
	3.5MM PLUG	MC1193	40	
	UHF PLUG	MC1224	43	
	BNC JACK	MC1218	40	
	BNC BULKHEAD JACK	MC1216	40	
	BNC PLUG	MC1036	41	
	SMA JACK	MC1020	42	
	SMA PLUG	MC1019	42	
	SMA PANEL JACK	MC1022	46	
	TNC JACK	MC1043	43	
TNC PLUG	MC1041	43		
N BLKH JACK	SMA JACK	MC1023	42	
	SMA JACK 18GHZ	MC1223	42	
N PLUG	N PLUG	MC3024	34	
	N RIGHT-ANGLE JACK	MC3027	35	
	N R/A RADIUS JACK	MC1321	35	
	BNC JACK	MC1035	41	

INTERFACE TO	INTERFACE	PART #	PAGE	
N PLUG	BNC JACK	MC1035	41	
	F JACK	MC1243	49	
	SMA JACK	MC1021	45	
	SMA PLUG	MC1018	45	
	SMB JACK	MC1235	45	
	SMC JACK	MC1234	45	
	TNC JACK	MC1040	45	
	TNC PLUG	MC1042	46	
	TNC JACK	TNC JACK	MC6006	33
		TNC BULKHEAD JACK	MC6007	33
TNC BLKHD JACK HERM		MC6008	34	
TNC BLKH JACK ISO/GRD		MC6009	34	
TNC PLUG		MC6011	34	
TNC RIGHT-ANGLE PLUG		MC6010	34	
BNC JACK		MC1037	41	
BNC PLUG		MC1038	42	
SMA PANEL JACK		MC1228	43	
SMA BULKHEAD JACK		MC1227	43	
	SMA JACK	MC1016	43	
	SMA PLUG	MC1015	44	
	SMA PANEL PLUG	MC1238	44	
	N PLUG	MC1040	45	
	N BLKHD JACK	MC1043	43	
TNC PLUG	TNC PLUG	MC6005	33	
	TNC JACK	MC6011	34	
	TNC RIGHT-ANGLE JACK	MC6010	34	
	BNC JACK	MC1039	41	
	BNC PLUG	MC1222	42	
	N BLKHD JACK	MC1041	43	
	N PLUG	MC1042	46	
	SMA PLUG	MC1014	44	
	SMA JACK	MC1017	43	
	7/16 JACK	7/16 JACK	MC3050	36
	7/16 PLUG	MC3051	36	
7/16 PLUG	7/16 JACK	MC3051	36	
	7/16 PLUG	MC3052	36	
F PLUG	F PLUG	MC1239	36	
	RCA JACK	MC1245	49	
	BNC JACK	MC1246	40	
F R/A PLUG	F JACK	MC1242	36	
F JACK	F JACK	MC1240	36	
	F BULKHEAD JACK	MC1241	36	
	N PLUG	MC1243	49	
	RCA PLUG	MC1244	49	
RCA PLUG	BNC JACK	MC1247	49	
	F JACK	MC1244	49	
RCA JACK	BNC PLUG	MC1248	49	
	F PLUG	MC1245	49	
7MM	2.9MM JACK	MC1212	39	
	2.9MM PLUG	MC1215	39	
	3.5MM JACK	MC1188	39	
	3.5MM PLUG	MC1192	40	
	SMA JACK	MC1153	44	
	SMA PLUG	MC1249	44	
BMA PLUG	SMA JACK	MC1232	45	
	SMA PLUG	MC1233	45	
BMA JACK	SMA JACK	MC1230	44	
	SMA PLUG	MC1231	45	
BMA BLKHD J	SMA JACK	MC1229	44	
UHF PLUG	N PLUG	MC1224	43	

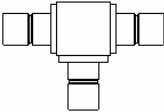
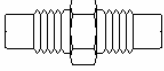

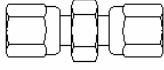
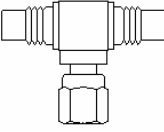
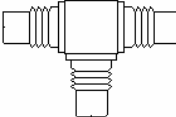
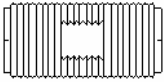

TEE ADAPTERS

INTERFACE TO	INTERFACE	PART #	PAGE
SMB	JACK/PLUG/JACK	MC5201	27
SMB	JACK/JACK/JACK	MC5202	28
SMC	JACK/PLUG/JACK	MC5087	28
SMC	JACK/JACK/JACK	MC5086	28
SMA	JACK/PLUG/JACK	MC2061	30
SMA	JACK/JACK/JACK	MC2062	30
BNC	JACK/PLUG/JACK	MC4030	33
BNC	JACK/JACK/JACK	MC4052	33
N	JACK/PLUG/JACK	MC3029	35
N	JACK/JACK/JACK	MC3028	35
TNC	JACK/PLUG/JACK	MC6012	34
TNC	JACK/JACK/JACK	MC6013	34

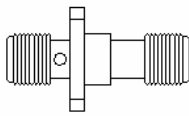
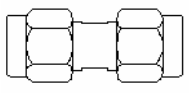
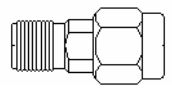
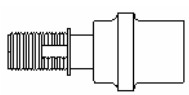
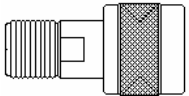
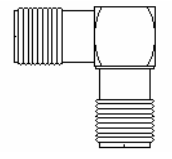
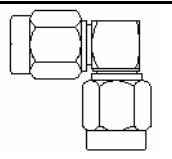
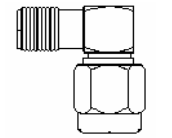
In-Series Adapters

	MODEL# MC5197	DESCRIPTION MMCX JACK/JACK	1-24 17.25	25-49 15.50	50-99 14.65	100+ 13.30
	MODEL# MC5198	DESCRIPTION MCX JACK/JACK	1-24 14.00	25-49 13.00	50-99 12.00	100+ 10.00
	MODEL# MC5199	DESCRIPTION MCX PLUG/PLUG	1-24 16.05	25-49 15.00	50-99 13.75	100+ 11.45
	MODEL# MC5200	DESCRIPTION SSMB BULKHEAD JACK/JACK	1-24 50.00	25-49 30.00	50-99 25.50	100+ 22.50
	MODEL# MC5080	DESCRIPTION SMB JACK/JACK	1-24 9.95	25-49 8.50	50-99 7.90	100+ 6.95
	MODEL# MC5084	DESCRIPTION SMB BLKH JACK/JACK USE MOUNTING #68	1-24 9.95	25-49 8.50	50-99 7.90	100+ 6.95
	MODEL# MC5082	DESCRIPTION SMB PLUG/PLUG	1-24 29.45	25-49 27.50	50-99 25.25	100+ 21.05
	MODEL# MC5201	DESCRIPTION SMB TEE JACK/PLUG/JACK	1-24 22.55	25-49 20.30	50-99 19.35	100+ 16.10

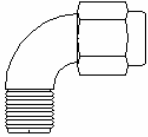
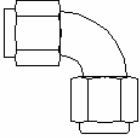
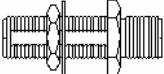
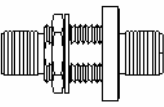
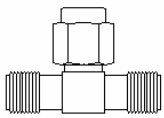
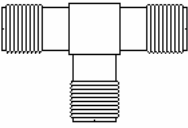
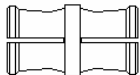
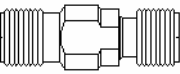
In-Series Adapters

	MODEL# MC5202	DESCRIPTION SMB TEE JACK/JACK/JACK	<u>1-24</u> 25.00	<u>25-49</u> 21.75	<u>50-99</u> 20.65	<u>100+</u> 18.75
	MODEL# MC5081	DESCRIPTION SMC JACK/JACK	<u>1-24</u> 30.60	<u>25-49</u> 26.55	<u>50-99</u> 13.05	<u>100+</u> 10.85
	MODEL# MC5085	DESCRIPTION SMC BULKHEAD JACK/JACK USE MOUNTING #68	<u>1-24</u> 19.90	<u>25-49</u> 18.25	<u>50-99</u> 16.35	<u>100+</u> 13.65
	MODEL# MC5083	DESCRIPTION SMC PLUG/PLUG	<u>1-24</u> 21.90	<u>25-49</u> 20.25	<u>50-99</u> 18.75	<u>100+</u> 16.20
	MODEL# MC5087	DESCRIPTION SMC TEE JACK/PLUG/JACK	<u>1-24</u> 25.00	<u>25-49</u> 21.75	<u>50-99</u> 26.65	<u>100+</u> 18.75
	MODEL# MC5086	DESCRIPTION SMC TEE JACK/JACK/JACK	<u>1-24</u> 25.00	<u>25-49</u> 21.75	<u>50-99</u> 20.65	<u>100+</u> 18.75
	MODEL# MC2054	DESCRIPTION SMA JACK/JACK	<u>1-24</u> 12.95	<u>25-49</u> 12.05	<u>50-99</u> 11.15	<u>100+</u> 10.35
	MODEL# MC2203	DESCRIPTION SMA JACK/JACK	<u>1-24</u> 17.85	<u>25-49</u> 16.35	<u>50-99</u> 14.75	<u>100+</u> 13.70

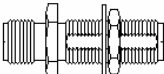
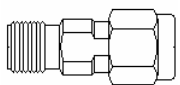
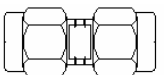
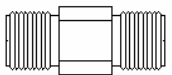
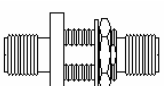
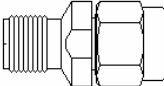
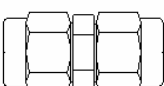
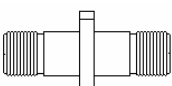
In-Series Adapters

	MODEL# MC1322	DESCRIPTION / CABLE TYPE SMA JACK / SMA 4-HOLE PANEL JACK	1-24 41.05	25-49 40.40	50-99 37.35	100+ 34.50
	MODEL# MC2053	DESCRIPTION SMA PLUG/PLUG	1-24 20.30	25-49 15.10	50-99 13.20	100+ 11.95
	MODEL# MC2055	DESCRIPTION SMA JACK/PLUG	1-24 22.00	25-49 17.25	50-99 15.00	100+ 13.50
	MODEL# MC2102	DESCRIPTION SMA JACK/PLUG QUICK RELEASE	1-24 97.35	25-49 86.25	50-99 75.50	100+ 72.85
	MODEL# MC2158	DESCRIPTION SMA JACK/PLUG QUICK MATE	1-24 39.65	25-49 34.20	50-99 31.00	100+ 28.25
	MODEL# MC2056	DESCRIPTION SMA R/A JACK/JACK	1-24 28.50	25-49 23.50	50-99 19.50	100+ 17.50
	MODEL# MC2058	DESCRIPTION SMA R/A PLUG/PLUG	1-24 28.50	25-49 23.50	50-99 19.50	100+ 17.50
	MODEL# MC2057	DESCRIPTION SMA R/A JACK/PLUG	1-24 18.95	25-49 18.00	50-99 15.75	100+ 14.00

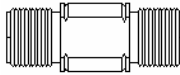
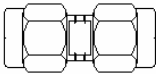
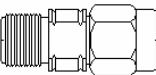
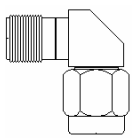

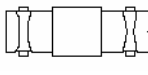
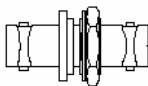
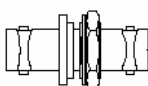
In-Series Adapters

	MODEL# MC2083	DESCRIPTION SMA RAD R/A JACK/PLUG	1-24 31.95	25-49 28.75	50-99 25.95	100+ 23.25
	MODEL# MC1320	DESCRIPTION / CABLE TYPE SMA PLUG / SMA PLUG RADIUS	1-24 43.10	25-49 40.95	50-99 38.00	100+ 35.25
	MODEL# MC2060	DESCRIPTION SMA BULKHEAD JACK/JACK USE MOUNTING #67	1-24 19.75	25-49 14.65	50-99 12.85	100+ 11.50
	MODEL# MC2059	DESCRIPTION SMA BULKHEAD JACK/JACK HERMETIC USE MOUNTING #68	1-24 29.95	25-49 27.50	50-99 24.30	100+ 21.65
	MODEL# MC2061	DESCRIPTION SMA TEE JACK/PLUG/JACK	1-24 43.85	25-49 41.80	50-99 37.60	100+ 32.50
	MODEL# MC2062	DESCRIPTION SMA TEE JACK/JACK/JACK	1-24 32.95	25-49 30.65	50-99 28.50	100+ 26.50
	MODEL# MC5203	DESCRIPTION SMP JACK/JACK	1-24 15.00	25-49 13.50	50-99 12.00	100+ 9.95
	MODEL# MC2145	DESCRIPTION 2.9MM JACK/JACK	1-24 109.95	25-49 103.00	50-99 86.90	100+ 70.80

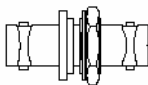
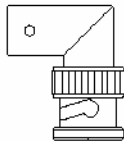

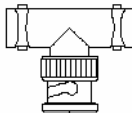
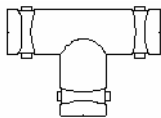
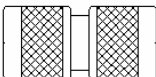
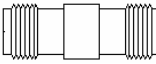
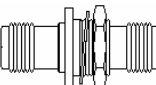
In-Series Adapters

	MODEL# MC2146	DESCRIPTION 2.9MM BULKHEAD JACK/JACK USE MOUNTING #68	<u>1-24</u> 124.95	<u>25-49</u> 118.95	<u>50-99</u> 99.00	<u>100+</u> 79.50
	MODEL# MC2147	DESCRIPTION 2.9MM JACK/PLUG	<u>1-24</u> 109.95	<u>25-49</u> 103.00	<u>50-99</u> 86.90	<u>100+</u> 70.80
	MODEL# MC2148	DESCRIPTION 2.9MM PLUG/PLUG	<u>1-24</u> 109.95	<u>25-49</u> 103.00	<u>50-99</u> 86.90	<u>100+</u> 70.80
	MODEL# MC2149	DESCRIPTION 3.5MM JACK/JACK	<u>1-24</u> 97.85	<u>25-49</u> 82.50	<u>50-99</u> 66.95	<u>100+</u> 51.50
	MODEL# MC2150	DESCRIPTION 3.5MM BULKHEAD JACK/JACK USE MOUNTING #66	<u>1-24</u> 124.95	<u>25-49</u> 118.95	<u>50-99</u> 99.00	<u>100+</u> 79.50
	MODEL# MC2151	DESCRIPTION 3.5MM JACK/PLUG	<u>1-24</u> 97.85	<u>25-49</u> 82.50	<u>50-99</u> 66.95	<u>100+</u> 51.50
	MODEL# MC2152	DESCRIPTION 3.5MM PLUG/PLUG	<u>1-24</u> 97.85	<u>25-49</u> 90.90	<u>50-99</u> 81.85	<u>100+</u> 68.20
	MODEL# MC2153	DESCRIPTION 3.5MM 4-HOLE PANEL JACK/JACK USE MOUNTING #98	<u>1-24</u> 124.95	<u>25-49</u> 118.95	<u>50-99</u> 99.00	<u>100+</u> 79.50

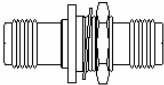
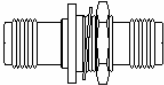
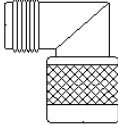
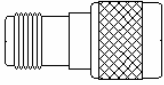
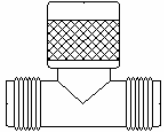
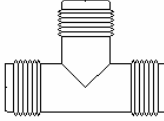
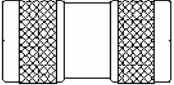

In-Series Adapters

	MODEL# MC2154	DESCRIPTION 2.4MM JACK/JACK	<u>1-24</u> 195.00	<u>25-49</u> 154.50	<u>50-99</u> 115.90	<u>100+</u> 95.50
	MODEL# MC2155	DESCRIPTION 2.4MM PLUG/PLUG	<u>1-24</u> 195.00	<u>25-49</u> 154.50	<u>50-99</u> 115.90	<u>100+</u> 95.50
	MODEL# MC2156	DESCRIPTION 2.4MM JACK/PLUG	<u>1-24</u> 195.00	<u>25-49</u> 154.50	<u>50-99</u> 115.90	<u>100+</u> 95.50
	MODEL# MC2157	DESCRIPTION 2.4MM RIGHT ANGLE JACK/PLUG	<u>1-24</u> 375.00	<u>25-49</u> 310.00	<u>50-99</u> 255.70	<u>100+</u> 202.40
	MODEL# MC4025	DESCRIPTION BNC PLUG/PLUG	<u>1-24</u> 5.95	<u>25-49</u> 5.00	<u>50-99</u> 4.50	<u>100+</u> 3.95
	MODEL# MC4026	DESCRIPTION BNC JACK/JACK	<u>1-24</u> 4.75	<u>25-49</u> 4.25	<u>50-99</u> 3.75	<u>100+</u> 3.30
	MODEL# MC4027	DESCRIPTION BNC BULKHEAD JACK/JACK USE MOUNTING #59	<u>1-24</u> 4.85	<u>25-49</u> 4.35	<u>50-99</u> 3.90	<u>100+</u> 3.50
	MODEL# MC4050	DESCRIPTION BNC BULKHEAD JACK/JACK HERMETIC USE MOUNTING #68	<u>1-24</u> 26.85	<u>25-49</u> 20.45	<u>50-99</u> 16.40	<u>100+</u> 14.35

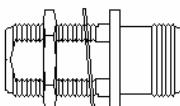
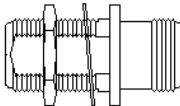
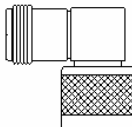
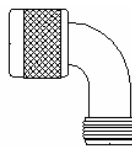
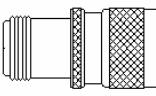
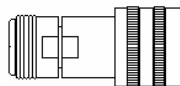
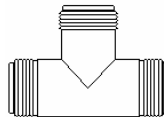
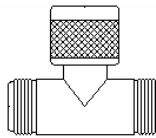
In-Series Adapters

	MODEL# MC4028	DESCRIPTION BNC BLKHD JACK/JACK ISOLATED GROUND USE MOUNTING #59	1-24 17.95	25-49 14.50	50-99 11.70	100+ 9.95
	MODEL# MC4029	DESCRIPTION BNC RIGHT-ANGLE JACK/PLUG	1-24 7.95	25-49 7.40	50-99 7.00	100+ 6.65
	MODEL# MC4051	DESCRIPTION BNC JACK/PLUG	1-24 26.45	25-49 23.80	50-99 19.35	100+ 17.40
	MODEL# MC4030	DESCRIPTION BNC TEE JACK/PLUG/JACK	1-24 14.95	25-49 13.50	50-99 12.10	100+ 10.95
	MODEL# MC4052	DESCRIPTION BNC TEE JACK/JACK/JACK	1-24 14.95	25-49 13.50	50-99 12.10	100+ 10.95
	MODEL# MC6005	DESCRIPTION TNC PLUG/PLUG	1-24 19.95	25-49 18.15	50-99 16.40	100+ 13.65
	MODEL# MC6006	DESCRIPTION TNC JACK/JACK	1-24 13.95	25-49 12.95	50-99 12.00	100+ 11.25
	MODEL# MC6007	DESCRIPTION TNC BULKHEAD JACK/JACK USE MOUNTING #59	1-24 18.65	25-49 17.50	50-99 16.00	100+ 13.35

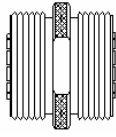
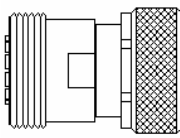
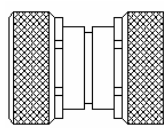
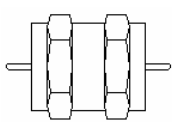
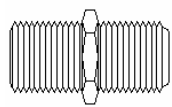
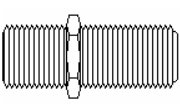
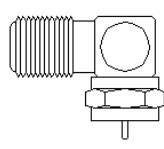
In-Series Adapters

	MODEL# MC6008	DESCRIPTION TNC BULKHEAD JACK/JACK, HERMETIC USE MOUNTING #59	<u>1-24</u> 25.50	<u>25-49</u> 22.95	<u>50-99</u> 20.65	<u>100+</u> 18.60
	MODEL# MC6009	DESCRIPTION TNC BULKHEAD JACK/JACK, ISOLATED GRND USE MOUNTING #59	<u>1-24</u> 15.95	<u>25-49</u> 14.85	<u>50-99</u> 13.75	<u>100+</u> 12.75
	MODEL# MC6010	DESCRIPTION TNC RIGHT-ANGLE JACK/PLUG	<u>1-24</u> 23.95	<u>25-49</u> 22.30	<u>50-99</u> 20.60	<u>100+</u> 19.15
	MODEL# MC6011	DESCRIPTION TNC JACK/PLUG	<u>1-24</u> 28.50	<u>25-49</u> 26.55	<u>50-99</u> 24.35	<u>100+</u> 20.30
	MODEL# MC6012	DESCRIPTION TNC TEE JACK/PLUG/JACK	<u>1-24</u> 28.50	<u>25-49</u> 26.55	<u>50-99</u> 24.35	<u>100+</u> 20.30
	MODEL# MC6013	DESCRIPTION TNC TEE JACK/JACK/JACK	<u>1-24</u> 28.50	<u>25-49</u> 26.55	<u>50-99</u> 24.35	<u>100+</u> 20.30
	MODEL# MC3024	DESCRIPTION N PLUG/PLUG	<u>1-24</u> 8.95	<u>25-49</u> 8.30	<u>50-99</u> 7.85	<u>100+</u> 7.40
	MODEL# MC3025	DESCRIPTION N JACK/JACK	<u>1-24</u> 8.95	<u>25-49</u> 8.30	<u>50-99</u> 7.85	<u>100+</u> 7.40

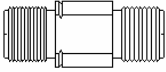
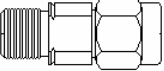
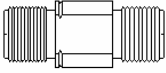
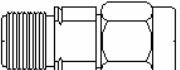
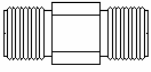

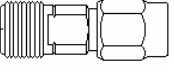

In-Series Adapters

	MODEL# MC3026	DESCRIPTION N BULKHEAD JACK/JACK USE MOUNTING #72	<u>1-24</u> 17.50	<u>25-49</u> 16.00	<u>50-99</u> 15.00	<u>100+</u> 12.50
	MODEL# MC3048	DESCRIPTION N BULKHEAD JACK/JACK,HERMETIC USE MOUNTING #72	<u>1-24</u> 28.50	<u>25-49</u> 21.85	<u>50-99</u> 18.50	<u>100+</u> 15.35
	MODEL# MC3027	DESCRIPTION N RIGHT-ANGLE JACK/PLUG	<u>1-24</u> 18.95	<u>25-49</u> 17.95	<u>50-99</u> 16.95	<u>100+</u> 15.95
	MODEL# MC1321	DESCRIPTION / CABLE TYPE N PLUG / N JACK RADIUS	<u>1-24</u> 244.25	<u>25-49</u> 176.00	<u>50-99</u> 141.00	<u>100+</u> 127.00
	MODEL# MC3049	DESCRIPTION N JACK/PLUG	<u>1-24</u> 32.25	<u>25-49</u> 28.30	<u>50-99</u> 26.25	<u>100+</u> 23.25
	MODEL# MC3053	DESCRIPTION N JACK/PLUG QUICK RELEASE	<u>1-24</u> 169.00	<u>25-49</u> 151.00	<u>50-99</u> 145.00	<u>100+</u> 121.00
	MODEL# MC3028	DESCRIPTION N TEE JACK/JACK/JACK	<u>1-24</u> 13.95	<u>25-49</u> 13.00	<u>50-99</u> 12.00	<u>100+</u> 11.15
	MODEL# MC3029	DESCRIPTION N TEE JACK/PLUG/JACK	<u>1-24</u> 13.95	<u>25-49</u> 13.00	<u>50-99</u> 12.00	<u>100+</u> 11.15

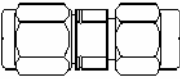
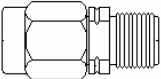
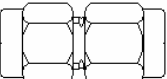
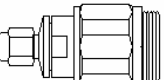
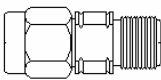
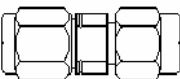
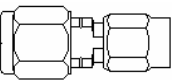
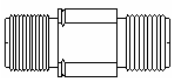
In-Series Adapters

	MODEL# MC3050	DESCRIPTION 7/16 JACK/JACK	1-24 64.95	25-49 60.50	50-99 55.85	100+ 51.95
	MODEL# MC3051	DESCRIPTION 7/16 JACK/PLUG	1-24 142.25	25-49 112.85	50-99 107.25	100+ 95.65
	MODEL# MC3052	DESCRIPTION 7/16 PLUG/PLUG	1-24 64.95	25-49 60.50	50-99 55.85	100+ 51.95
	MODEL# MC1239	DESCRIPTION / CABLE TYPE F PLUG/PLUG	1-24 7.95	25-49 7.40	50-99 6.85	100+ 6.35
	MODEL# MC1240	DESCRIPTION / CABLE TYPE F BULKHEAD JACK/JACK	1-24 3.50	25-49 3.25	50-99 3.00	100+ 2.85
	MODEL# MC1241	DESCRIPTION / CABLE TYPE F BULKHEAD JACK/JACK LENG	1-24 3.50	25-49 3.25	50-99 3.00	100+ 2.85
	MODEL# MC1242	DESCRIPTION / CABLE TYPE RIGHT-ANGLE PLUG/JACK	1-24 5.95	25-49 5.65	50-99 5.40	100+ 5.00

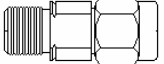
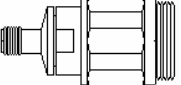
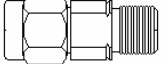
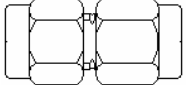
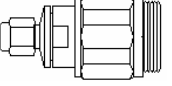
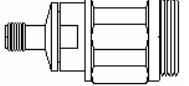
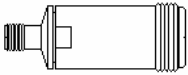
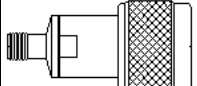
Between Series Adapters

	MODEL# MC1195	DESCRIPTION 2.4MM JACK / 2.9MM JACK	<u>1-24</u> 169.95	<u>25-49</u> 127.45	<u>50-99</u> 108.65	<u>100+</u> 88.65
	MODEL# MC1196	DESCRIPTION 2.4MM JACK / 2.9MM PLUG	<u>1-24</u> 169.95	<u>25-49</u> 127.45	<u>50-99</u> 108.65	<u>100+</u> 88.65
	MODEL# MC1197	DESCRIPTION 2.4MM JACK / 3.5MM JACK	<u>1-24</u> 169.95	<u>25-49</u> 127.45	<u>50-99</u> 108.65	<u>100+</u> 88.65
	MODEL# MC1198	DESCRIPTION 2.4MM JACK / 3.5MM PLUG	<u>1-24</u> 169.95	<u>25-49</u> 127.45	<u>50-99</u> 108.65	<u>100+</u> 88.65
	MODEL# MC1199	DESCRIPTION 2.4MM JACK / SMA JACK	<u>1-24</u> 102.95	<u>25-49</u> 92.95	<u>50-99</u> 85.95	<u>100+</u> 79.95
	MODEL# MC1200	DESCRIPTION 2.4MM JACK / SMA PLUG	<u>1-24</u> 102.95	<u>25-49</u> 92.95	<u>50-99</u> 85.95	<u>100+</u> 79.95
	MODEL# MC1201	DESCRIPTION 2.4MM JACK / SSMA PLUG	<u>1-24</u> 169.95	<u>25-49</u> 127.45	<u>50-99</u> 108.65	<u>100+</u> 88.65
	MODEL# MC1202	DESCRIPTION 2.4MM PLUG / 2.9MM JACK	<u>1-24</u> 169.95	<u>25-49</u> 127.45	<u>50-99</u> 108.65	<u>100+</u> 88.65

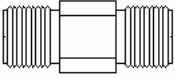
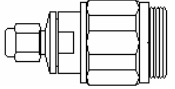
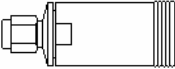
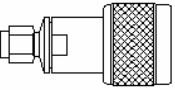
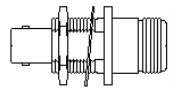
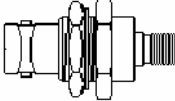
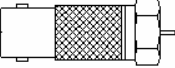
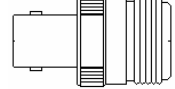
Between Series Adapters

	MODEL# MC1203	DESCRIPTION 2.4MM PLUG / 2.9MM PLUG	<u>1-24</u> 169.95	<u>25-49</u> 127.45	<u>50-99</u> 108.05	<u>100+</u> 88.65
	MODEL# MC1204	DESCRIPTION 2.4MM PLUG / 3.5MM JACK	<u>1-24</u> 169.95	<u>25-49</u> 127.45	<u>50-99</u> 108.05	<u>100+</u> 88.65
	MODEL# MC1205	DESCRIPTION 2.4MM PLUG / 3.5MM PLUG	<u>1-24</u> 169.95	<u>25-49</u> 127.45	<u>50-99</u> 108.05	<u>100+</u> 88.65
	MODEL# MC1206	DESCRIPTION 2.4MM PLUG / 7MM	<u>1-24</u> 219.95	<u>25-49</u> 204.50	<u>50-99</u> 189.15	<u>100+</u> 175.95
	MODEL# MC1207	DESCRIPTION 2.4MM PLUG / SMA JACK	<u>1-24</u> 102.95	<u>25-49</u> 92.95	<u>50-99</u> 85.95	<u>100+</u> 79.95
	MODEL# MC1208	DESCRIPTION 2.4MM PLUG / SMA PLUG	<u>1-24</u> 102.95	<u>25-49</u> 92.95	<u>50-99</u> 85.95	<u>100+</u> 79.95
	MODEL# MC1209	DESCRIPTION 2.4MM PLUG / SSMA PLUG	<u>1-24</u> 169.95	<u>25-49</u> 127.45	<u>50-99</u> 108.05	<u>100+</u> 88.65
	MODEL# MC1210	DESCRIPTION 2.9MM JACK / 3.5MM JACK	<u>1-24</u> 102.95	<u>25-49</u> 97.95	<u>50-99</u> 85.95	<u>100+</u> 79.95

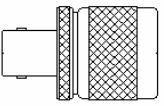
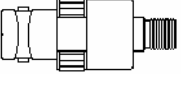
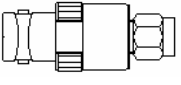
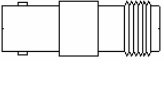
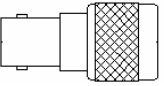
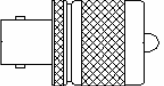
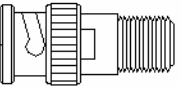
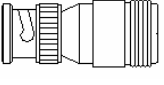
Between Series Adapters

	MODEL# MC1211	DESCRIPTION 2.9MM JACK / 3.5MM PLUG	<u>1-24</u> 102.95	<u>25-49</u> 92.95	<u>50-99</u> 85.95	<u>100+</u> 79.95
	MODEL# MC1212	DESCRIPTION / CABLE TYPE 2.9MM JACK / 7MM	<u>1-24</u> 219.95	<u>25-49</u> 204.50	<u>50-99</u> 189.15	<u>100+</u> 175.95
	MODEL# MC1213	DESCRIPTION / CABLE TYPE 2.9MM PLUG / 3.5MM JACK	<u>1-24</u> 102.95	<u>25-49</u> 92.95	<u>50-99</u> 85.95	<u>100+</u> 79.95
	MODEL# MC1214	DESCRIPTION / CABLE TYPE 2.9MM PLUG / 3.5MM PLUG	<u>1-24</u> 102.95	<u>25-49</u> 92.95	<u>50-99</u> 85.95	<u>100+</u> 79.95
	MODEL# MC1215	DESCRIPTION / CABLE TYPE 2.9MM PLUG / 7MM	<u>1-24</u> 219.95	<u>25-49</u> 204.50	<u>50-99</u> 189.15	<u>100+</u> 175.95
	MODEL# MC1188	DESCRIPTION / CABLE TYPE 3.5MM JACK / 7MM	<u>1-24</u> 256.40	<u>25-49</u> 238.00	<u>50-99</u> 219.80	<u>100+</u> 183.10
	MODEL# MC1189	DESCRIPTION / CABLE TYPE 3.5MM JACK / N JACK	<u>1-24</u> 99.95	<u>25-49</u> 92.95	<u>50-99</u> 85.95	<u>100+</u> 79.95
	MODEL# MC1190	DESCRIPTION / CABLE TYPE 3.5MM JACK / N PLUG	<u>1-24</u> 99.95	<u>25-49</u> 92.95	<u>50-99</u> 85.95	<u>100+</u> 79.95

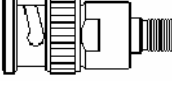
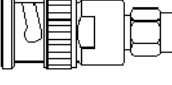
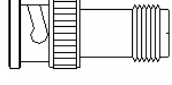
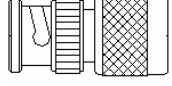
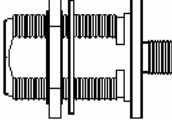
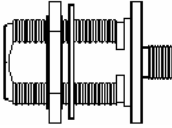
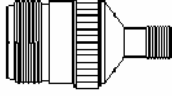
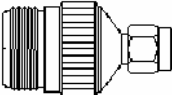
Between Series Adapters

	MODEL# MC1191	DESCRIPTION / CABLE TYPE 3.5MM JACK / SMA JACK	1-24 99.95	25-49 92.95	50-99 85.95	100+ 79.95
	MODEL# MC1192	DESCRIPTION / CABLE TYPE 3.5MM PLUG / 7MM	1-24 256.40	25-49 238.00	50-99 219.80	100+ 183.10
	MODEL# MC1193	DESCRIPTION / CABLE TYPE 3.5MM PLUG / N JACK	1-24 99.95	25-49 92.95	50-99 85.95	100+ 79.95
	MODEL# MC1194	DESCRIPTION / CABLE TYPE 3.5MM PLUG / N PLUG	1-24 99.95	25-49 92.95	50-99 85.95	100+ 79.95
	MODEL# MC1216	DESCRIPTION / CABLE TYPE BNC BULKHEAD JACK / N JACK USE MOUNTING #72	1-24 48.50	25-49 43.65	50-99 38.20	100+ 34.35
	MODEL# MC1013	DESCRIPTION / CABLE TYPE BNC BULKHEAD JACK / SMA JACK USE MOUNTING #59	1-24 40.95	25-49 36.95	50-99 34.25	100+ 30.95
	MODEL# MC1246	DESCRIPTION / CABLE TYPE BNC JACK / F PLUG	1-24	25-49	50-99	100+
	MODEL# MC1218	DESCRIPTION / CABLE TYPE BNC JACK / N JACK	1-24 12.50	25-49 11.70	50-99 10.95	100+ 10.30

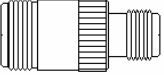
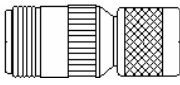
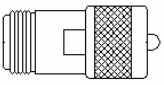
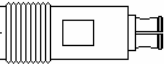
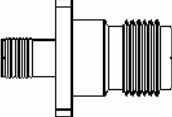
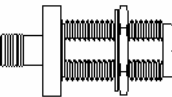
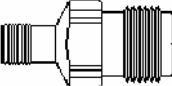
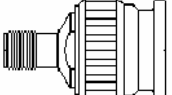
Between Series Adapters

	MODEL# MC1035	DESCRIPTION / CABLE TYPE BNC JACK / N PLUG	1-24 7.95	25-49 7.25	50-99 6.75	100+ 6.25
	MODEL# MC1011	DESCRIPTION / CABLE TYPE BNC JACK / SMA JACK	1-24 33.45	25-49 25.48	50-99 22.65	100+ 21.65
	MODEL# MC1010	DESCRIPTION / CABLE TYPE BNC JACK / SMA PLUG	1-24 35.10	25-49 30.60	50-99 26.80	100+ 22.75
	MODEL# MC1037	DESCRIPTION / CABLE TYPE BNC JACK / TNC JACK	1-24 12.95	25-49 12.00	50-99 11.00	100+ 10.25
	MODEL# MC1039	DESCRIPTION / CABLE TYPE BNC JACK / TNC PLUG	1-24 12.95	25-49 12.00	50-99 11.00	100+ 10.25
	MODEL# MC1219	DESCRIPTION / CABLE TYPE BNC JACK / UHF PLUG	1-24 14.45	25-49 13.45	50-99 12.65	100+ 11.90
	MODEL# MC1220	DESCRIPTION / CABLE TYPE BNC PLUG / F JACK	1-24 12.50	25-49 11.70	50-99 10.95	100+ 10.30
	MODEL# MC1036	DESCRIPTION / CABLE TYPE BNC PLUG / N JACK	1-24 16.95	25-49 14.40	50-99 11.15	100+ 9.48

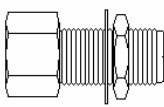
Between Series Adapters

	MODEL# MC1012	DESCRIPTION / CABLE TYPE BNC PLUG / SMA JACK	<u>1-24</u> 32.60	<u>25-49</u> 24.85	<u>50-99</u> 22.10	<u>100+</u> 21.15
	MODEL# MC1009	DESCRIPTION / CABLE TYPE BNC PLUG / SMA PLUG	<u>1-24</u> 21.95	<u>25-49</u> 20.35	<u>50-99</u> 18.50	<u>100+</u> 17.50
	MODEL# MC1038	DESCRIPTION / CABLE TYPE BNC PLUG / TNC JACK	<u>1-24</u> 15.95	<u>25-49</u> 12.05	<u>50-99</u> 11.10	<u>100+</u> 10.35
	MODEL# MC1222	DESCRIPTION / CABLE TYPE BNC PLUG / TNC PLUG	<u>1-24</u> 16.95	<u>25-49</u> 15.75	<u>50-99</u> 14.55	<u>100+</u> 13.50
	MODEL# MC1023	DESCRIPTION / CABLE TYPE N BULKHEAD JACK / SMA JACK USE MOUNTING #72	<u>1-24</u> 81.80	<u>25-49</u> 71.55	<u>50-99</u> 63.60	<u>100+</u> 57.30
	MODEL# MC1223	DESCRIPTION / CABLE TYPE 18GHZ N BULKHEAD JACK / SMA JACK USE MOUNTING #72	<u>1-24</u> 88.65	<u>25-49</u> 75.65	<u>50-99</u> 68.05	<u>100+</u> 61.25
	MODEL# MC1020	DESCRIPTION / CABLE TYPE N JACK / SMA JACK	<u>1-24</u> 31.95	<u>25-49</u> 27.05	<u>50-99</u> 25.15	<u>100+</u> 22.10
	MODEL# MC1019	DESCRIPTION / CABLE TYPE N JACK / SMA PLUG	<u>1-24</u> 39.00	<u>25-49</u> 37.85	<u>50-99</u> 32.20	<u>100+</u> 26.85

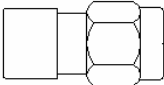
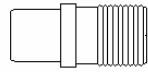
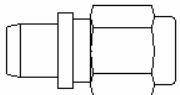
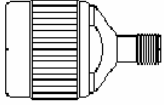
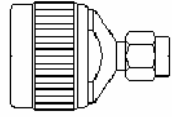
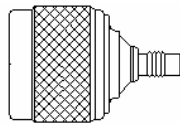
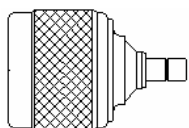
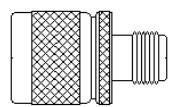
Between Series Adapters

	MODEL# MC1043	DESCRIPTION / CABLE TYPE N JACK / TNC JACK	1-24 23.95	25-49 22.95	50-99 22.00	100+ 19.15
	MODEL# MC1041	DESCRIPTION / CABLE TYPE N JACK / TNC PLUG	1-24 13.95	25-49 12.95	50-99 12.00	100+ 11.15
	MODEL# MC1224	DESCRIPTION / CABLE TYPE N JACK / UHF PLUG	1-24 12.95	25-49 12.05	50-99 11.15	100+ 10.35
	MODEL# MC1225	DESCRIPTION / CABLE TYPE SMA JACK / SMP JACK	1-24 64.95	25-49 60.45	50-99 55.85	100+ 51.95
	MODEL# MC1228	DESCRIPTION / CABLE TYPE SMA JACK / TNC PANEL JACK USE MOUNTING #07	1-24 64.50	25-49 58.05	50-99 55.15	100+ 52.35
	MODEL# MC1227	DESCRIPTION / CABLE TYPE SMA JACK / TNC BULKHEAD JACK USE MOUNTING #62	1-24 85.55	25-49 76.95	50-99 69.30	100+ 65.80
	MODEL# MC1016	DESCRIPTION / CABLE TYPE SMA JACK / TNC JACK	1-24 25.95	25-49 24.10	50-99 22.30	100+ 20.75
	MODEL# MC1017	DESCRIPTION / CABLE TYPE SMA JACK / TNC PLUG	1-24 43.50	25-49 36.60	50-99 33.25	100+ 30.25

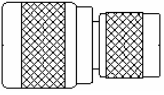
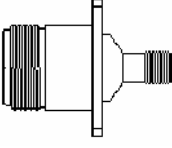
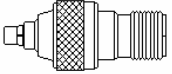
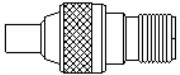
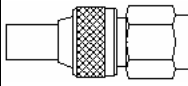
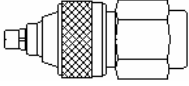
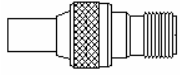
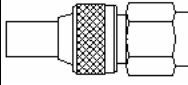
Between Series Adapters

	MODEL# MC1153	DESCRIPTION / CABLE TYPE SMA JACK / 7MM	1-24 173.50	25-49 161.05	50-99 154.90	100+ 148.70
	MODEL# MC1249	DESCRIPTION / CABLE TYPE SMA PLUG / 7MM	1-24 218.70	25-49 213.25	50-99 192.00	100+ 160.00
	MODEL# MC1237	DESCRIPTION / CABLE TYPE SMA PLUG / SMP PLUG	1-24 64.95	25-49 60.40	50-99 55.85	100+ 51.95
	MODEL# MC1015	DESCRIPTION / CABLE TYPE SMA PLUG / TNC JACK	1-24 46.80	25-49 40.10	50-99 39.00	100+ 33.45
	MODEL# MC1014	DESCRIPTION / CABLE TYPE SMA PLUG / TNC PLUG	1-24 46.80	25-49 40.10	50-99 39.00	100+ 33.45
	MODEL# MC1238	DESCRIPTION / CABLE TYPE SMA PLUG / TNC PANEL JACK USE MOUNTING #07	1-24 95.15	25-49 90.60	50-99 86.25	100+ 82.15
	MODEL# MC1229	DESCRIPTION / CABLE TYPE BMA JACK / SMA BULKHEAD JACK USE MOUNTING #67	1-24 69.75	25-49 60.75	50-99 53.25	100+ 48.25
	MODEL# MC1230	DESCRIPTION / CABLE TYPE BMA JACK / SMA JACK	1-24 49.05	25-49 36.95	50-99 33.60	100+ 31.35

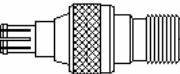
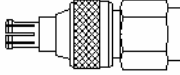
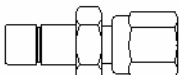
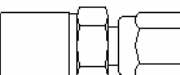
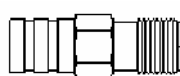
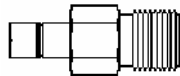


Between Series Adapters

	MODEL# MC1231	DESCRIPTION / CABLE TYPE BMA JACK / SMA PLUG	1-24 54.65	25-49 47.10	50-99 40.25	100+ 38.45
	MODEL# MC1232	DESCRIPTION / CABLE TYPE BMA PLUG / SMA JACK	1-24 28.00	25-49 24.50	50-99 21.35	100+ 19.25
	MODEL# MC1233	DESCRIPTION / CABLE TYPE BMA PLUG / SMA PLUG	1-24 43.60	25-49 37.55	50-99 32.10	100+ 30.75
	MODEL# MC1021	DESCRIPTION / CABLE TYPE N PLUG / SMA JACK	1-24 29.95	25-49 27.85	50-99 25.75	100+ 23.95
	MODEL# MC1018	DESCRIPTION / CABLE TYPE N PLUG / SMA PLUG	1-24 51.15	25-49 44.60	50-99 39.05	100+ 35.45
	MODEL# MC1234	DESCRIPTION / CABLE TYPE N PLUG / SMC JACK	1-24 31.65	25-49 27.25	50-99 23.25	100+ 22.25
	MODEL# MC1235	DESCRIPTION / CABLE TYPE N PLUG / SMB JACK	1-24 31.65	25-49 27.25	50-99 23.25	100+ 22.25
	MODEL# MC1040	DESCRIPTION / CABLE TYPE N PLUG / TNC JACK	1-24 14.95	25-49 13.90	50-99 12.85	100+ 11.95

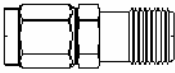
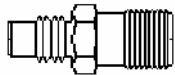
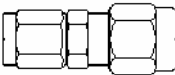
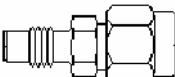
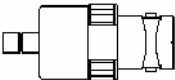
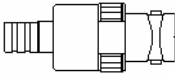
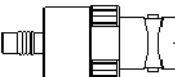
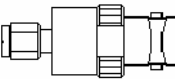
Between Series Adapters

	MODEL# MC1042	DESCRIPTION / CABLE TYPE N PLUG / TNC PLUG	1-24 14.95	25-49 13.90	50-99 12.85	100+ 11.95
	MODEL# MC1022	DESCRIPTION / CABLE TYPE N PANEL JACK / SMA JACK USE MOUNTING #33	1-24 37.15	25-49 32.00	50-99 27.35	100+ 26.25
	MODEL# MC1177	DESCRIPTION / CABLE TYPE MMCX PLUG / SMA JACK	1-24 47.95	25-49 44.55	50-99 41.25	100+ 38.35
	MODEL# MC1178	DESCRIPTION / CABLE TYPE MMCX JACK / SMA JACK	1-24 47.95	25-49 44.55	50-99 41.25	100+ 38.35
	MODEL# MC1179	DESCRIPTION / CABLE TYPE MMCX JACK / SMA PLUG	1-24 47.95	25-49 44.55	50-99 41.25	100+ 38.35
	MODEL# MC1180	DESCRIPTION / CABLE TYPE MMCX PLUG / SMA PLUG	1-24 47.95	25-49 44.55	50-99 41.25	100+ 38.35
	MODEL# MC1181	DESCRIPTION / CABLE TYPE MCX JACK / SMA JACK	1-24 15.95	25-49 14.35	50-99 13.65	100+ 12.95
	MODEL# MC1182	DESCRIPTION / CABLE TYPE MCX JACK / SMA PLUG	1-24 15.95	25-49 14.35	50-99 13.65	100+ 12.95

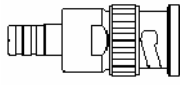
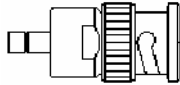
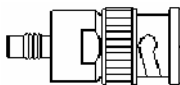
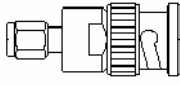
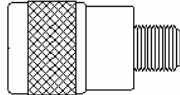
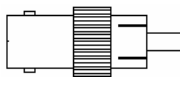
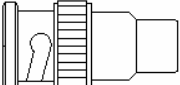
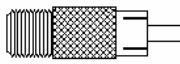
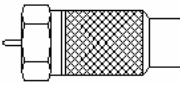
Between Series Adapters

	MODEL# MC1183	DESCRIPTION / CABLE TYPE MCX PLUG / SMA JACK	<u>1-24</u> 15.95	<u>25-49</u> 14.35	<u>50-99</u> 13.65	<u>100+</u> 12.95
	MODEL# MC1184	DESCRIPTION / CABLE TYPE MCX PLUG / SMA PLUG	<u>1-24</u> 15.95	<u>25-49</u> 14.35	<u>50-99</u> 13.65	<u>100+</u> 12.95
	MODEL# MC1186	DESCRIPTION / CABLE TYPE SMB JACK / SMC PLUG	<u>1-24</u> 39.80	<u>25-49</u> 29.76	<u>50-99</u> 21.80	<u>100+</u> 18.10
	MODEL# MC1187	DESCRIPTION / CABLE TYPE SMB PLUG / SMC PLUG	<u>1-24</u> 49.80	<u>25-49</u> 34.40	<u>50-99</u> 27.75	<u>100+</u> 18.35
	MODEL# MC1005	DESCRIPTION / CABLE TYPE SMB PLUG / SMA JACK	<u>1-24</u> 15.95	<u>25-49</u> 14.35	<u>50-99</u> 13.65	<u>100+</u> 12.95
	MODEL# MC1007	DESCRIPTION / CABLE TYPE SMB JACK / SMA JACK	<u>1-24</u> 15.95	<u>25-49</u> 14.35	<u>50-99</u> 13.65	<u>100+</u> 12.95
	MODEL# MC1001	DESCRIPTION / CABLE TYPE SMB PLUG / SMA PLUG	<u>1-24</u> 15.95	<u>25-49</u> 14.35	<u>50-99</u> 13.65	<u>100+</u> 12.95
	MODEL# MC1003	DESCRIPTION / CABLE TYPE SMB JACK / SMA PLUG	<u>1-24</u> 15.95	<u>25-49</u> 14.35	<u>50-99</u> 13.65	<u>100+</u> 12.95

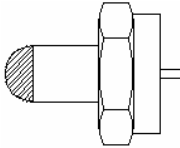

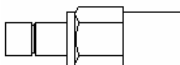
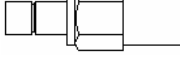
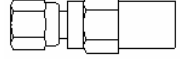

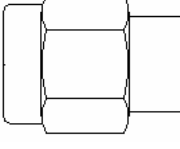
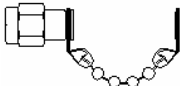

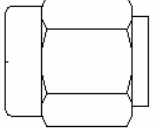
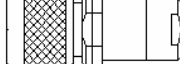
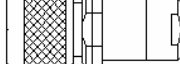
Between Series Adapters

	MODEL# MC1006	DESCRIPTION / CABLE TYPE SMC PLUG / SMA JACK	<u>1-24</u> 15.95	<u>25-49</u> 14.35	<u>50-99</u> 13.65	<u>100+</u> 12.95
	MODEL# MC1008	DESCRIPTION / CABLE TYPE SMC JACK / SMA JACK	<u>1-24</u> 15.95	<u>25-49</u> 14.35	<u>50-99</u> 13.65	<u>100+</u> 12.95
	MODEL# MC1002	DESCRIPTION / CABLE TYPE SMC PLUG / SMA PLUG	<u>1-24</u> 15.95	<u>25-49</u> 14.35	<u>50-99</u> 13.65	<u>100+</u> 12.95
	MODEL# MC1004	DESCRIPTION / CABLE TYPE SMC JACK / SMA PLUG	<u>1-24</u> 15.95	<u>25-49</u> 14.35	<u>50-99</u> 13.65	<u>100+</u> 12.95
	MODEL# MC1027	DESCRIPTION / CABLE TYPE SMB JACK / BNC JACK	<u>1-24</u> 20.10	<u>25-49</u> 17.35	<u>50-99</u> 14.85	<u>100+</u> 14.15
	MODEL# MC1025	DESCRIPTION / CABLE TYPE SMB PLUG / BNC JACK	<u>1-24</u> 24.40	<u>25-49</u> 23.25	<u>50-99</u> 20.90	<u>100+</u> 18.05
	MODEL# MC1032	DESCRIPTION / CABLE TYPE SMC JACK / BNC JACK	<u>1-24</u> 20.10	<u>25-49</u> 17.35	<u>50-99</u> 14.80	<u>100+</u> 14.15
	MODEL# MC1030	DESCRIPTION / CABLE TYPE SMC PLUG / BNC JACK	<u>1-24</u> 27.95	<u>25-49</u> 24.10	<u>50-99</u> 20.60	<u>100+</u> 19.70

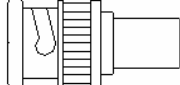
Between Series Adapters

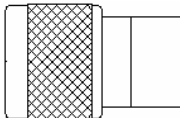

	MODEL# MC1026	DESCRIPTION / CABLE TYPE SMB PLUG / BNC PLUG	<u>1-24</u> 33.30	<u>25-49</u> 28.70	<u>50-99</u> 24.50	<u>100+</u> 23.45
	MODEL# MC1028	DESCRIPTION / CABLE TYPE SMB JACK / BNC PLUG	<u>1-24</u> 23.30	<u>25-49</u> 20.00	<u>50-99</u> 17.10	<u>100+</u> 16.35
	MODEL# MC1033	DESCRIPTION / CABLE TYPE SMC JACK / BNC PLUG	<u>1-24</u> 23.30	<u>25-49</u> 20.00	<u>50-99</u> 17.10	<u>100+</u> 16.35
	MODEL# MC1031	DESCRIPTION / CABLE TYPE SMC PLUG / BNC PLUG	<u>1-24</u> 33.30	<u>25-49</u> 28.70	<u>50-99</u> 24.50	<u>100+</u> 23.45
	MODEL# MC1243	DESCRIPTION / CABLE TYPE F JACK/N PLUG	<u>1-24</u> 3.40	<u>25-49</u> 3.00	<u>50-99</u> 2.75	<u>100+</u> 2.45
	MODEL# MC1247	DESCRIPTION / CABLE TYPE BNC JACK / RCA PLUG	<u>1-24</u> 2.00	<u>25-49</u> 1.90	<u>50-99</u> 1.80	<u>100+</u> 1.75
	MODEL# MC1248	DESCRIPTION / CABLE TYPE BNC PLUG / RCA JACK	<u>1-24</u> 1.90	<u>25-49</u> 1.85	<u>50-99</u> 1.80	<u>100+</u> 1.75
	MODEL# MC1244	DESCRIPTION / CABLE TYPE F JACK / RCA PLUG	<u>1-24</u> 1.90	<u>25-49</u> 1.85	<u>50-99</u> 1.80	<u>100+</u> 1.75
	MODEL# MC1245	DESCRIPTION / CABLE TYPE F PLUG / RCA JACK	<u>1-24</u> 1.90	<u>25-49</u> 1.85	<u>50-99</u> 1.80	<u>100+</u> 1.75

Terminations

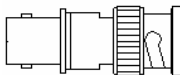
	MODEL# MC1250	DESCRIPTION F PLUG - NO CHAIN		WATTS 0.5W		1-24 4.50	25-49 4.00	50-99 3.50	100+ 3.00
	MODEL# MC1251	DESCRIPTION SMB PLUG - NO CHAIN		WATTS 0.5W		1-24 16.95	25-49 15.75	50-99 14.60	100+ 13.55
	MC1252	SMB JACK - NO CHAIN		0.5W		21.95	20.50	18.75	17.55
	MC1255	SMB PLUG - 75 OHM - NO CHAIN		0.5W		22.25	20.50	18.45	16.45
	MODEL# MC1253	DESCRIPTION SMC PLUG / NO CHAIN		WATTS 0.5W		1-24 22.25	25-49 20.50	50-99 18.45	100+ 16.45
	MC1254	SMC JACK / NO CHAIN		0.5W		22.25	20.50	18.45	16.45
	MODEL# MC1256 MC1257 MC1258 MC1259 MC1260 MC1261	DESCRIPTION SMA PLUG / NO CHAIN SMA PLUG / NO CHAIN SMA PLUG / NO CHAIN SMA PLUG / NO CHAIN SMA PLUG / NO CHAIN SMA PLUG / NO CHAIN	FREQ 1 GHZ 2 GHZ 6 GHZ 12 GHZ 18 GHZ 18 GHZ	WATTS 0.5W 0.5W 0.5W 0.5W 0.5W 1.0W	MAX VSWR 1.10 1.20 1.23 1.15	1-24 13.95 14.95 15.95 16.95 22.55 30.05	25-49 12.95 13.95 14.95 15.95 20.30 29.00	50-99 12.00 13.40 14.40 15.00 18.80 26.95	100+ 11.15 12.15 13.15 14.15 16.95 24.25
	MC1262 MC1263 MC1264	SMA PLUG / NO CHAIN SMA PLUG / NO CHAIN SMA PLUG / WITH CHAIN	18 GHZ 26 GHZ 18 GHZ	1.0W 1.0W 1.0W	1.20 1.10 1.23	37.50 59.95 38.95	36.25 55.95 36.25	33.75 51.60 33.50	30.50 47.95 31.25
	MC1265 MC1266	SMA JACK / NO CHAIN SMA JACK / NO CHAIN	1 GHZ 18 GHZ	0.5W 0.5W	1.10 1.23	13.95 130.00	12.95 123.50	12.00 117.35	11.15 111.15
	MODEL# MC1267	DESCRIPTION 2.4MM PLUG / NO CHAIN	FREQ 50 GHZ	WATTS 0.5W	MAX VSWR 1.30	1-24 295.00	25-49 280.25	50-99 266.25	100+ 252.95
	MODEL# MC1268	DESCRIPTION 2.9MM PLUG / NO CHAIN	FREQ 40 GHZ	WATTS 2.0W	MAX VSWR 1.25	1-24 95.00	25-49 75.00	50-99 65.25	100+ 60.00
	MODEL# MC1273	DESCRIPTION TNC PLUG / NO CHAIN	FREQ 2 GHZ	WATTS 2.0W	MAX VSWR 1.15	1-24 46.50	25-49 44.50	50-99 43.50	100+ 42.50
	MC1274	TNC PLUG / WITH CHAIN	2 GHZ	2.0W	1.20	46.50	44.50	43.50	42.50
	MC1275	TNC PLUG / NO CHAIN	18 GHZ	2.0W	1.25	63.05	59.90	56.90	54.05
	MC1276	TNC PLUG / WITH CHAIN	18 GHZ	2.0W	1.25	64.50	61.30	58.25	55.35

Terminations

	<u>MODEL#</u>	<u>DESCRIPTION</u>	<u>FREQ</u>	<u>WATTS</u>	<u>MAX VSWR</u>	<u>1-24</u>	<u>25-49</u>	<u>50-99</u>	<u>100+</u>
	MC1269	BNC PLUG / NO CHAIN				6.90	5.50	4.65	3.50
	MC1270	BNC PLUG / WITH CHAIN				6.90	5.50	4.65	3.50
	MC1271	BNC PLUG / NO CHAIN	2 GHZ	2.0W	1.20	19.50	17.35	15.95	14.75
	MC1272	BNC PLUG / WITH CHAIN	2 GHZ	2.0W	1.20	23.95	21.25	19.50	18.25
	MC1283	BNC PLUG / 75 OHM / NO CHAIN				6.95	5.95	4.95	3.95
	MC1284	BNC PLUG / 75 OHM / WITH CHAIN				9.95	8.95	7.65	6.95

	<u>MODEL#</u>	<u>DESCRIPTION</u>	<u>FREQ</u>	<u>WATTS</u>	<u>MAX VSWR</u>	<u>1-24</u>	<u>25-49</u>	<u>50-99</u>	<u>100+</u>
	MC1277	N PLUG / NO CHAIN	7 GHZ	2.0W	1.20	16.25	15.40	14.65	13.90
	MC1278	N PLUG / WITH CHAIN	2 GHZ	2.0W	1.20	45.00	44.15	42.80	41.50
	MC1279	N PLUG / NO CHAIN	12 GHZ	2.0W	1.15	45.00	44.15	42.80	41.50
	MC1280	N PLUG / WITH CHAIN	12 GHZ	2.0W	1.05	47.65	46.25	44.85	43.50
	MC1281	N PLUG / NO CHAIN	18 GHZ	2.0W	1.20	61.60	59.75	57.95	56.25
	MC1282	N PLUG / WITH CHAIN	18 GHZ	2.0W	1.20	64.55	62.60	60.75	58.95


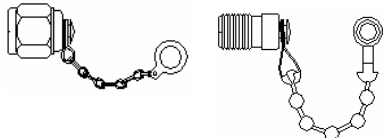
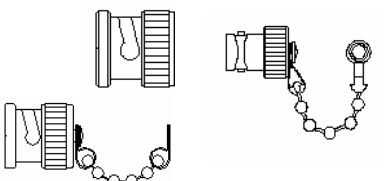
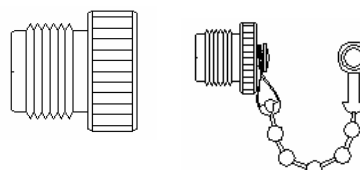
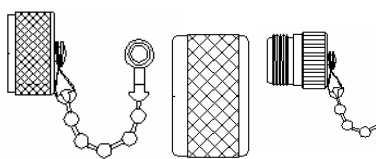
Feed-thru Terminations

	<u>MODEL#</u>	<u>DESCRIPTION</u>	<u>FREQ</u>	<u>WATTS</u>	<u>MAX VSWR</u>	<u>1-24</u>	<u>25-49</u>	<u>50-99</u>	<u>100+</u>
	MC1317	BNC JACK/PLUG	1 GHZ	1.0W	1.20:1	26.90	25.50	24.65	23.50

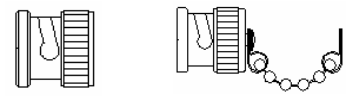
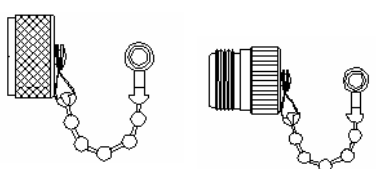
In addition to our Standard offering of Terminations, Microwave Components also offers a broad range of Mil-Approved (QPL) versions in accordance with Mil-DTL-39030.

Contact our Sales Department for Price & Delivery at 1-800-282-4771 or email us at admin@microwavecomponentsinc.com

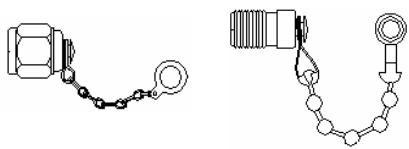
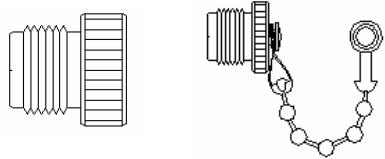
Opens/Caps

	MODEL#	DESCRIPTION	1-24	25-49	50-99	100+
	MC1285	SSMA PLUG / NO CHAIN	21.20	18.00	15.30	13.00
	MC1286	SSMA PLUG / WITH CHAIN	24.45	20.75	17.65	15.00
	MC1287	SSMA JACK / NO CHAIN	21.20	18.00	15.30	13.00
	MC1288	SSMA JACK / WITH CHAIN	24.95	20.75	17.65	15.00
	MODEL#	DESCRIPTION	1-24	25-49	50-99	100+
	MC1289	SMA PLUG / NO CHAIN	5.50	4.00	3.50	3.00
	MC1290	SMA PLUG / WITH CHAIN	5.50	5.00	4.75	4.40
	MC1291	SMA JACK / WITH CHAIN	7.75	7.25	6.65	6.25
	MODEL#	DESCRIPTION	1-24	25-49	50-99	100+
	MC1292	BNC PLUG / NO CHAIN	2.50	2.30	2.15	2.00
	MC1293	BNC PLUG / WITH CHAIN	2.75	2.60	2.40	2.20
	MC1294	BNC JACK / NO CHAIN	3.60	3.35	3.10	2.90
	MC1295	BNC JACK / WITH CHAIN	3.90	3.65	3.35	3.10
	MODEL#	DESCRIPTION	1-24	25-49	50-99	100+
	MC1296	TNC PLUG / NO CHAIN	4.15	3.85	3.60	3.30
	MC1297	TNC PLUG / WITH CHAIN	4.40	4.00	3.75	3.50
	MC1298	TNC JACK / WITH CHAIN	6.75	6.25	5.80	5.40
	MODEL#	DESCRIPTION	1-24	25-49	50-99	100+
	MC1299	N PLUG / NO CHAIN	3.60	3.35	3.10	2.90
	MC1300	N PLUG / WITH CHAIN	3.90	3.60	3.35	3.10
	MC1301	N JACK / NO CHAIN	7.65	7.40	7.15	6.95
	MC1302	N JACK / WITH CHAIN	5.50	5.00	4.75	4.40

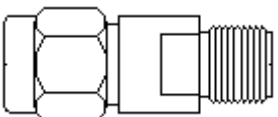
Shorting Caps

	MODEL#	DESCRIPTION	1-24	25-49	50-99	100+
	MC1303	BNC PLUG / NO CHAIN	5.50	5.00	4.75	4.50
	MC1304	BNC PLUG / WITH CHAIN	6.75	6.25	5.75	5.50
	MODEL#	DESCRIPTION	1-24	25-49	50-99	100+
	MC1307	N PLUG / NO CHAIN	10.95	10.15	9.40	8.75
	MC1308	N PLUG / WITH CHAIN	11.95	11.00	10.25	9.55
	MC1309	N JACK / NO CHAIN	11.95	11.00	10.25	9.55
	MC1310	N JACK / WITH CHAIN	12.95	12.00	11.25	10.55

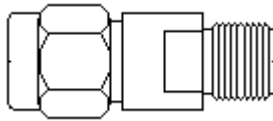
Shorting Caps

	MODEL#	DESCRIPTION	1-24	25-49	50-99	100+
	MC1311	SMA PLUG / NO CHAIN	11.95	11.00	10.25	9.55
	MC1312	SMA PLUG / WITH CHAIN	12.95	12.00	11.25	10.55
	MC1313	SMA JACK / NO CHAIN	12.95	12.00	11.25	10.55
	MC1314	SMA JACK / WITH CHAIN	13.95	13.00	12.25	11.55
	MODEL#	DESCRIPTION	1-24	25-49	50-99	100+
	MC1315	TNC PLUG / NO CHAIN	15.00	13.50	12.95	10.95
	MC1316	TNC JACK / WITH CHAIN	15.95	14.00	13.25	11.55

SMA Attenuators 2w/1.15 Max VSWR

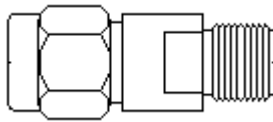
							
DC 4GHZ ATTENUATORS							
MODEL#	OH LENGTH	ATTENUATION	ACCURACY	1-24	25-49	50-99	100+
MC2177-4	.860	1 dB	±0.5 dB	32.95	29.65	26.50	24.50
MC2178-4	.860	2 dB	±0.5 dB	32.95	29.65	26.50	24.50
MC2179-4	.860	3 dB	±0.5 dB	32.95	29.65	26.50	24.50
MC2180-4	.860	4 dB	±0.5 dB	32.95	29.65	26.50	24.50
MC2181-4	.860	5 dB	±0.5 dB	32.95	29.65	26.50	24.50
MC2182-4	.860	6 dB	±0.75 dB	32.95	29.65	26.50	24.50
MC2183-4	.860	7 dB	±0.75 dB	32.95	29.65	26.50	24.50
MC2184-4	.860	8 dB	±0.75 dB	32.95	29.65	26.50	24.50
MC2185-4	.860	9 dB	±0.75 dB	32.95	29.65	26.50	24.50
MC2186-4	.860	10 dB	±0.75 dB	32.95	29.65	26.50	24.50
MC2187-4	.860	11 dB	±0.75 dB	32.95	29.65	26.50	24.50
MC2188-4	.860	12 dB	±0.75 dB	32.95	29.65	26.50	24.50
MC2189-4	.860	13 dB	±0.75 dB	32.95	29.65	26.50	24.50
MC2190-4	.860	14 dB	±0.75 dB	32.95	29.65	26.50	24.50
MC2191-4	.860	15 dB	±0.75 dB	32.95	29.65	26.50	24.50
MC2192-4	.860	20 dB	±1.0 dB	32.95	29.65	26.50	24.50
MC2193-4	.860	30 dB	±1.0 dB	32.95	29.65	26.50	24.50
MC2194-4	.860	40 dB	±1.0 dB	32.95	29.65	26.50	24.50

SMA ATTENUATORS/2W/1.35 MAX VSWR



**12 GHZ
ATTENUATORS**

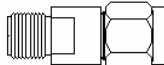
<u>MODEL#</u>	<u>OH LENGTH</u>	<u>ATTENUATION</u>	<u>ACCURACY</u>	<u>1-24</u>	<u>25-49</u>	<u>50-99</u>	<u>100+</u>
MC2177-12	.860	1 dB	±0.5 dB	36.95	32.95	29.45	26.95
MC2178-12	.860	2 dB	±0.5 dB	36.95	32.95	29.45	26.95
MC2179-12	.860	3 dB	±0.5 dB	36.95	32.95	29.45	26.95
MC2180-12	.860	4 dB	±0.5 dB	36.95	32.95	29.45	26.95
MC2181-12	.860	5 dB	±0.5 dB	36.95	32.95	29.45	26.95
MC2182-12	.860	6 dB	±0.5 dB	36.95	32.95	29.45	26.95
MC2183-12	.860	7 dB	±0.5 dB	36.95	32.95	29.45	26.95
MC2184-12	.860	8 dB	±0.5 dB	36.95	32.95	29.45	26.95
MC2185-12	.860	9 dB	±0.5 dB	36.95	32.95	29.45	26.95
MC2186-12	.860	10 dB	±0.5 dB	36.95	32.95	29.45	26.95
MC2187-12	.860	11 dB	±0.75 dB	36.95	32.95	29.45	26.95
MC2188-12	.860	12 dB	±0.75 dB	36.95	32.95	29.45	26.95
MC2189-12	.860	13 dB	±0.75 dB	36.95	32.95	29.45	26.95
MC2190-12	.860	14 dB	±0.75 dB	36.95	32.95	29.45	26.95
MC2191-12	.860	15 dB	±0.75 dB	36.95	32.95	29.45	26.95
MC2192-12	.860	20 dB	±0.75 dB	36.95	32.95	29.45	26.95
MC2193-12	.860	30 dB	±1.0 dB	36.95	32.95	29.45	26.95
MC2194-12	.860	40 dB	±1.0 dB	36.95	32.95	29.45	26.95



**18 GHZ
ATTENUATORS**

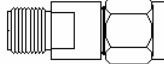
<u>MODEL#</u>	<u>OH LENGTH</u>	<u>ATTENUATION</u>	<u>ACCURACY</u>	<u>1-24</u>	<u>25-49</u>	<u>50-99</u>	<u>100+</u>
MC2177-18	.860	1 dB	±0.3 dB	59.65	49.70	41.45	34.55
MC2178-18	.860	2 dB	±0.3 dB	59.65	49.70	41.45	34.55
MC2179-18	.860	3 dB	±0.3 dB	59.65	49.70	41.45	34.55
MC2180-18	.860	4 dB	±0.3 dB	59.65	49.70	41.45	34.55
MC2181-18	.860	5 dB	±0.3 dB	59.65	49.70	41.45	34.55
MC2182-18	.860	6 dB	±0.3 dB	59.65	49.70	41.45	34.55
MC2183-18	.860	7 dB	±0.3 dB	59.65	49.70	41.45	34.55
MC2184-18	.860	8 dB	±0.3 dB	59.65	49.70	41.45	34.55
MC2185-18	.860	9 dB	±0.3 dB	59.65	49.70	41.45	34.55
MC2186-18	.860	10 dB	±0.5 dB	59.65	49.70	41.45	34.55
MC2187-18	.860	11 dB	±0.5 dB	59.65	49.70	41.45	34.55
MC2188-18	.860	12 dB	±0.5 dB	59.65	49.70	41.45	34.55
MC2189-18	.860	13 dB	±0.5 dB	59.65	49.70	41.45	34.55
MC2190-18	.860	14 dB	±0.5 dB	59.65	49.70	41.45	34.55
MC2191-18	.860	15 dB	±0.5 dB	59.65	49.70	41.45	34.55
MC2192-18	.860	20 dB	±0.75 dB	59.65	49.70	41.45	34.55
MC2193-18	.860	30 dB	±1.0 dB	59.65	49.70	41.45	34.55
MC2194-18	.860	40 dB	±1.0 dB	59.65	49.70	41.45	34.55

2.9MM ATTENUATORS 0.5W/1.40 MAX VSWR

	<u>MODEL#</u>	<u>OH LENGTH</u>	<u>ATTENUATION</u>	<u>ACCURACY</u>	<u>1-24</u>	<u>25-49</u>	<u>50-99</u>	<u>100+</u>
	MC2195	.87	3 dB	±0.5 dB@26.5 GHZ	195.25	155.50	124.95	99.50
	MC2196	.87	6 dB	±0.8 dB@40 GHZ	195.25	155.50	124.95	99.50
	MC2197	.87	10 dB	±0.6 dB@26.5 GHZ	195.25	155.50	124.95	99.50
	MC2198	.87	20 dB	±1.0 dB@40 GHZ	195.25	155.50	124.95	99.50

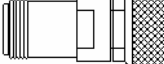
DC -40GHZ

2.4MM ATTENUATORS 0.5W/1.65 MAX VSWR

	<u>MODEL#</u>	<u>OH LENGTH</u>	<u>ATTENUATION</u>	<u>ACCURACY</u>	<u>1-24</u>	<u>25-49</u>	<u>50-99</u>	<u>100+</u>
	MC2199	.87	3 dB	±0.5 dB@26.5 GHZ	340.00	255.00	191.25	153.00
	MC2200	.87	6 dB	±0.8 dB@40 GHZ	340.00	255.00	191.25	153.00
	MC2201	.87	10 dB	±0.6 dB@26.5 GHZ	340.00	255.00	191.25	153.00
	MC2202	.87	20 dB	±1.0 dB@40 GHZ	340.00	255.00	191.25	153.00


DC-50GHZ

N ATTENUATORS 2W/1.15 MAX VSWR

	<u>MODEL#</u>	<u>OH LENGTH</u>	<u>ATTENUATION</u>	<u>ACCURACY</u>	<u>1-24</u>	<u>25-49</u>	<u>50-99</u>	<u>100+</u>
	MC3054	2.25	3 dB	±0.3 dB	39.95	38.95	37.95	36.95
	MC3055	2.25	6 dB	±0.3 dB	39.95	38.95	37.95	36.95
	MC3056	2.25	10 dB	±0.5 dB	39.95	38.95	37.95	36.95
	MC3057	2.25	20 dB	±0.75 dB	39.95	38.95	37.95	36.95
	MC3058	2.25	30 dB	±1.0 dB	39.95	38.95	37.95	36.95

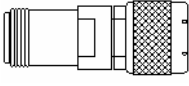
DC-4GHZ

N ATTENUATORS 2W/1.25 MAX VSWR

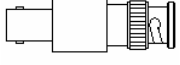
	<u>MODEL#</u>	<u>OH LENGTH</u>	<u>ATTENUATION</u>	<u>ACCURACY</u>	<u>1-24</u>	<u>25-49</u>	<u>50-99</u>	<u>100+</u>
	MC3059	2.25	3 dB	±0.3 dB	40.95	39.95	38.95	37.95
	MC3060	2.25	6 dB	±0.3 dB	40.95	39.95	38.95	37.95
	MC3061	2.25	10 dB	±0.5 dB	40.95	39.95	38.95	37.95
	MC3062	2.25	20 dB	±0.75 dB	40.95	39.98	38.95	37.95
	MC3063	2.25	30 dB	±1.0 dB	40.95	39.98	38.95	37.95

DC-12GHZ

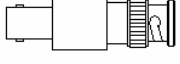
N ATTENUATORS 2W/1.35 MAX VSWR

	<u>MODEL#</u>	<u>OH LENGTH</u>	<u>ATTENUATION</u>	<u>ACCURACY</u>	<u>1-24</u>	<u>25-49</u>	<u>50-99</u>	<u>100+</u>
	DC-18GHZ	MC3064	2.25	3 dB	±0.3 dB	49.95	48.95	47.95
MC3065		2.25	6 dB	±0.3 dB	49.95	48.95	47.95	46.95
MC3066		2.25	10 dB	±0.5 dB	49.95	49.95	47.95	46.95
MC3067		2.25	20 dB	±0.75 dB	49.95	48.95	47.95	46.95
MC3068		2.25	30 dB	±1.0 dB	49.95	48.95	47.95	46.95

BNC ATTENUATORS 1W/1.40 MAX VSWR

	<u>MODEL#</u>	<u>DESCRIPTION / CABLE TYPE</u>	<u>1-24</u>	<u>25-49</u>	<u>50-99</u>	<u>100+</u>
	DC-2GHZ	MC4053	1.43 / ATTENUATION: 3 / ±0.5 dB@1GHZ	23.95	22.00	20.50
MC4054		1.43 / ATTENUATION: 6 / ±0.8 dB@2GHZ	23.95	22.00	20.50	19.00
MC4055		1.43 / ATTENUATION: 10 / ±0.8 dB@2GHZ	23.95	22.00	20.50	19.00
MC4056		1.43 / ATTENUATION: 20 / ±0.8 dB@2GHZ	23.95	22.00	20.50	19.00
MC4057		1.43 / ATTENUATION: 30 / ±0.8 dB@2GHZ	23.95	22.00	20.50	19.00

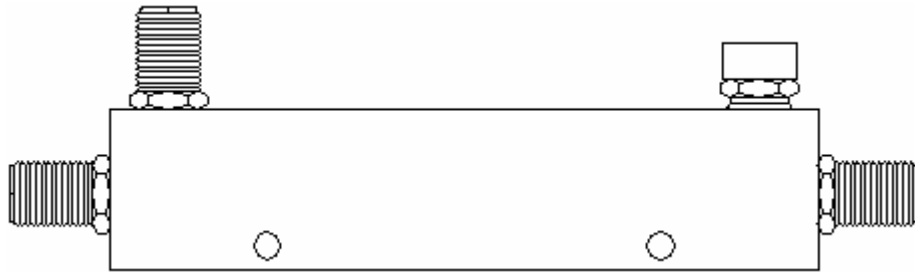
BNC ATTENUATORS 2W/1.25 MAX VSWR

	<u>MODEL#</u>	<u>DESCRIPTION / CABLE TYPE</u>	<u>1-24</u>	<u>25-49</u>	<u>50-99</u>	<u>100+</u>
	DC-4GHZ	MC4058	2.15 / ATTENUATION: 3 / 0.3 dB@2GHZ	68.50	63.70	59.45
MC4059		2.15 / ATTENUATION: 6 / 0.4 dB@4GHZ	68.50	63.70	59.45	55.70
MC4060		2.15 / ATTENUATION: 10 / 0.4 dB@4GHZ	68.50	63.70	59.45	55.70
MC4061		2.15 / ATTENUATION: 20 / 0.4 dB@4GHZ	68.50	63.70	59.45	55.70
MC4062		2.15 / ATTENUATION: 30 / 0.4 dB@4GHZ	68.50	63.70	59.45	55.70

In addition to our Standard offering of Attenuators, Microwave Components also offers a broad range of Mil-Approved (QPL) versions in accordance with Mil-A-3933/14 thru Mil-A-3933/25.

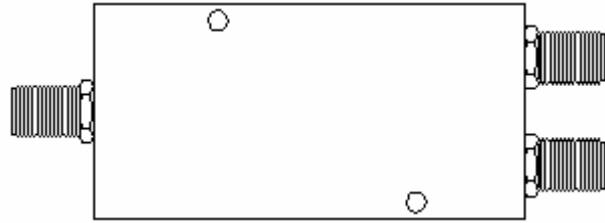
**Contact our Sales Department for Price & Delivery
At 1-800-282-4771 or email us at
admin@microwavecomponentsinc.com**

DIRECTIONAL COUPLERS



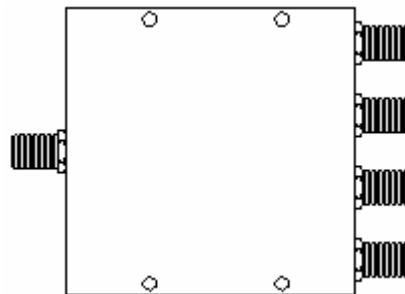
MODEL#	DESCRIPTION	FREQ. RANGE (GHz)	COUPLING		INSERTION LOSS MAX. (dB)	DIR. MIN. (dB)	VSWR (MAX.)	P (kW)	P			
			INCLUDES FREQ. SENS. (dB)	FREQ. SENS. (dB)					1-9	10-24	25.49	50+
MC1117	2020-6600-06	0.5-1.0	6±1.0	0.60	0.15	25	1.10	4	238.45	202.65	192.50	182.95
MC1118	2020-6601-10	0.5-1.0	10±1.0	0.75	0.15	25	1.10	4	238.45	202.65	192.50	182.95
MC1119	2020-6602-20	0.5-1.0	20±1.0	0.75	0.15	25	1.10	4	238.45	202.65	192.50	182.95
MC1120	2020-6603-30	0.5-1.0	30±1.0	0.75	0.15	25	1.10	4	238.45	202.65	192.50	182.95
MC1121	2020-6604-06	1.0-2.0	6±1.0	0.60	0.20	25	1.15	4	221.45	198.25	178.75	169.95
MC1122	2020-6605-10	1.0-2.0	10±1.0	0.75	1.20	25	1.15	4	221.45	198.25	178.75	169.95
MC1123	2020-6606-20	1.0-2.0	20±1.0	0.75	0.20	25	1.15	4	221.45	198.25	178.75	169.95
MC1124	2020-6607-30	1.0-2.0	30±1.0	0.75	0.20	25	1.15	4	221.45	198.25	178.75	169.95
MC1125	2020-6608-06	2.0-4.0	6±1.0	0.60	0.20	22	1.15	4	221.45	198.25	178.75	169.95
MC1126	2020-6609-10	2.0-4.0	10±1.0	0.75	0.20	22	1.15	4	221.45	198.25	178.75	169.95
MC1127	2020-6610-20	2.0-4.0	20±1.0	0.75	0.20	22	1.15	4	221.45	198.25	178.75	169.95
MC1128	2020-6611-30	2.0-4.0	30±1.0	0.75	0.20	22	1.15	4	221.45	198.25	178.75	169.95
MC1129	2020-6612-06	2.6-5.2	6±1.0	0.60	0.25	20	1.25	4	221.45	198.25	178.75	169.95
MC1130	2020-6613-10	2.6-5.2	10±1.0	0.75	0.25	20	1.25	4	221.45	198.25	178.75	169.95
MC1131	2020-6614-20	2.6-5.2	20±1.0	0.75	0.25	20	1.25	4	221.45	198.25	178.75	169.95
MC1132	2020-6615-30	2.6-5.2	30±1.0	0.75	0.25	20	1.25	4	221.45	198.25	178.75	169.95
MC1133	2020-6616-06	4.0-8.0	6±.75	0.50	0.25	22	1.25	4	221.45	198.25	178.75	169.95
MC1134	2020-6617-10	4.0-8.0	10±.75	0.50	0.25	20	1.25	4	221.45	198.25	178.75	169.95
MC1135	2020-6618-20	4.0-8.0	20±.75	0.50	0.25	20	1.25	4	221.45	198.25	178.75	169.95
MC1136	2020-6619-30	4.0-8.0	30±.75	0.50	0.25	20	1.25	4	221.45	198.25	178.75	169.95
MC1137	2020-6620-06	7.0-12.4	6±1.0	0.40	0.40	15	1.35	4	231.75	198.25	187.15	177.60
MC1138	2020-6621-10	7.0-12.4	10±.75	0.40	0.40	20	1.30	4	231.75	198.25	187.15	177.60
MC1139	2020-6622-20	7.0-12.4	20±.75	0.50	0.30	18	1.35	4	231.75	198.25	187.15	177.60
MC1140	2020-6623-30	7.0-12.4	30±1.0	0.50	0.30	17	1.35	4	231.75	198.25	187.15	177.60
MC1141	2020-6624-06	7.0-18.0	6±1.0	0.50	0.50	15	1.35	3	262.45	223.05	211.95	201.30
MC1142	2020-6625-10	7.0-18.0	10±1.0	0.50	0.40	20	1.30	3	262.45	223.05	211.95	201.30
MC1143	2020-6626-20	7.0-18.0	20±1.0	0.75	0.50	15	1.45	3	262.45	223.05	211.95	201.30
MC1144	2020-6627-30	7.0-18.0	30±1.0	0.75	0.50	15	1.45	3	262.45	223.05	211.95	201.30
MC1145	2020-6628-06	12.4-18.0	6±.75	0.40	0.50	15	1.40	2	254.70	215.65	204.85	194.60
MC1146	2020-6629-10	12.4-18.0	10±.75	0.40	0.40	20	1.30	2	254.70	215.65	204.85	194.60
MC1147	2020-6630-20	12.4-18.0	20±.75	0.50	0.50	17	1.45	2	254.70	215.65	204.85	194.60
MC1148	2020-6631-30	12.4-18.0	30±1.0	0.50	0.50	12	1.45	2	254.70	215.65	204.85	194.60

TWO-WAY POWER DIVIDERS



<u>MODEL#</u>	<u>CONN. TYPE</u>	<u>FREQ. RANGE (GHZ)</u>	<u>VSWR (MAX)</u>	<u>ISOLATION dB (MIN)</u>	<u>ISOLATION LOSS dB (MAX)</u>	<u>AMPLITUDE</u>	<u>1-9</u>	<u>10-24</u>	<u>25-49</u>	<u>50+</u>
MC1154	SMA	1.0-2.0	1.25	20	0.25	0.2	220.50	199.25	189.25	179.90
MC1090	SMA	2.0-4.0	1.35	20	0.25	0.2	220.50	199.25	189.25	179.90
MC1095	SMA	4.0-8.0	1.35	20	0.3	0.2	220.50	199.25	189.25	179.90
MC1096	SMA	8.0-12.4	1.60	20	0.4	0.25	241.85	217.65	206.75	196.25
MC1097	SMA	12.4-18.0	1.70	17	0.6	0.25	256.00	230.45	218.95	220.80
MC1098	SMA	0.5-2.0	1.30	20	0.4	0.2	363.00	329.65	313.00	297.50
MC1099	SMA	2.0-8.0	1.50	18	0.4	0.25	389.00	329.65	313.00	197.50
MC1100	SMA	2.0-18.0	1.60	17	1.0	0.25	493.00	417.50	396.75	375.95
MC1101	SMA	4.0-18.0	1.60	17	0.6	0.25	493.00	417.50	396.75	375.95
MC1102	SMA	7.0-18.0	1.70	17	0.6	0.25	493.00	417.50	396.75	375.95

FOUR-WAY POWER DIVIDERS



<u>MODEL#</u>	<u>CONN. TYPE</u>	<u>FREQ. RANGE (GHZ)</u>	<u>VSWR (MAX)</u>	<u>ISOLATION dB (MIN)</u>	<u>INSERTION LOSS dB (MAX)</u>	<u>AMPLITUDE BALANCE (dB)</u>	<u>1-9</u>	<u>10-24</u>	<u>25-49</u>	<u>50+</u>
MC1103	SMA	1.0-2.0	1.35	20	0.50	0.40	356.35	320.75	305.65	289.50
MC1104	SMA	2.0-4.0	1.35	20	0.50	0.40	356.35	320.75	305.65	289.50
MC1109	SMA	4.0-8.0	1.50	20	0.50	0.40	377.35	320.75	304.65	289.50
MC1110	SMA	8.0-12.4	1.70	18	0.75	0.50	387.50	350.25	332.75	316.00
MC1111	SMA	12.4-18.0	1.70	15	1.20	0.50	451.65	382.55	363.45	345.50
MC1112	SMA	0.5-2.0	1.45	20	0.70	0.40	522.95	486.25	461.95	438.85
MC1113	SMA	2.0-8.0	1.60	18	0.80	0.50	522.95	486.25	461.95	438.85
MC1114	SMA	2.0-18.0	1.70	17	1.80	0.50	696.25	608.00	576.75	547.85
MC1115	SMA	4.0-18.0	1.70	15	1.20	0.50	657.50	573.15	545.95	517.25
MC1116	SMA	7.0-18.0	1.60	15	1.20	0.50	570.00	530.00	503.50	478.50

CABLE FLEXIBLE & SEMI-RIGID

SEMI-RIGID COAXIAL CABLE

<u>MODEL#</u>	<u>DIAMETER</u>	<u>MATERIAL</u>	<u>50 FT</u>	<u>100 FT</u>	<u>250 FT</u>	<u>500FT</u>	<u>1000FT</u>
MC7117	.034	PLAIN COPPER	3.65	3.20	2.80	2.50	2.20
MC7118	.034	SILVER PLATED COPPER	4.55	4.10	3.65	3.35	2.95
MC7119	.034	TIN PLATED COPPER	4.10	3.65	3.20	2.90	2.45
MC7120	.047	PLAIN COPPER	3.05	2.65	2.35	2.25	2.00
MC7141	.047	M17/151-00001	3.05	2.65	2.35	2.25	2.00
MC7121	.047	SILVER PLATED COPPER	4.10	3.85	3.35	3.10	3.00
MC7122	.047	TIN PLATED COPPER	2.65	2.40	2.15	1.90	1.80
MC7013	.085	PLAIN COPPER	2.45	2.15	1.95	1.40	1.30
MC7142	.085	M17/133-RG405	2.45	2.15	1.95	1.40	1.30
MC7123	.085	SILVER PLATED COPPER	5.65	5.25	4.05	3.05	2.70
MC7124	.085	TIN PLATED COPPER	2.75	2.45	2.25	1.70	1.65
MC7143	.085	M17/130-00001	2.75	2.45	2.25	1.70	1.65
MC7012	.141	PLAIN COPPER	3.75	3.25	2.80	1.95	1.75
MC7144	.141	M17/130-RG402	3.75	3.25	2.80	1.95	1.75
MC7125	.141	SILVER PLATED COPPER	6.95	6.05	5.15	4.05	3.80
MC7126	.141	TIN PLATED COPPER	4.00	3.55	3.10	2.30	2.10
MC7145	.141	M17/133-00001	4.00	3.55	3.10	2.30	2.10
MC7011	.250	PLAIN COPPER	12.65	11.00	9.35	7.00	5.20
MC7127	.250	SILVER PLATED COPPER	18.30	15.95	13.55	8.60	7.65
MC7128	.250	TIN PLATED COPPER	14.00	12.15	10.35	8.15	6.65

HAND-FORMABLE CABLES

<u>MODEL#</u>	<u>DIAMETER</u>	<u>MATERIAL</u>	<u>50 FT</u>	<u>100 FT</u>	<u>250 FT</u>	<u>500 FT</u>	<u>1000 FT</u>
MC7137	.047	BRAIDED/SOLDER-DIPPED	2.15	1.86	1.58	1.35	1.30
MC7135	.085	BRAIDED/SOLDER-DIPPED	2.10	1.80	1.53	1.30	1.15
MC7136	.141	BRAIDED/SOLDER-DIPPED	2.26	1.92	1.63	1.39	1.25

FLEXIBLE CABLE

<u>MODEL#</u>	<u>DESCRIPTION</u>	<u>MANUFACTURER</u>	<u>100 FT</u>	<u>500 FT</u>	<u>1000 FT</u>
MC7001	M17/60-RG142	HARBOUR INDUSTRIES	2.50	2.25	2.00
MC7006	M17/75-RG214	TIMES	3.70	3.10	2.80
MC7007	M17/78-RG217	TIMES	2.50	2.10	1.80
MC7008	M17/84-RG223	TIMES	1.85	1.70	1.50
MC7003	M17/43-RG178	HARBOUR INDUSTRIES	.50	.45	.40
MC7004	M17/94-RG179	HARBOUR INDUSTRIES	.70	.68	.63
MC7009	M17/113-RG316	HARBOUR INDUSTRIES	.70	.60	.54
MC7134	M17/127-RG393	TIMES	6.65	5.50	4.95
MC7010	M17/128-RG400	HARBOUR INDUSTRIES	3.00	2.60	2.10
MC7140	M17/152-00001	HARBOUR INDUSTRIES	1.05	.97	.90
MC7130	EF178*	HUBER & SUHNER	.88	.75	.68
MC7014	RD178**	TIMES	2.10	1.90	1.70
MC7131	EF179*	HUBER & SUHNER	1.08	.92	.79
MC7132	RD179**	TIMES	3.15	2.81	2.53
MC7133	EF316*	HUBER & SUHNER	.58	.49	.42
MC7154	EF316D*	HUBER & SUHNER	.85	.64	.61
MC7015	RD316**	TIMES	3.20	2.90	2.60
MC7129	EF142*	HUBER & SUHNER	1.56	1.30	1.10
MC7022	SF316	TIMES	2.35	2.10	1.87
MC7023	SFT316	TIMES	6.42	5.46	4.65
MC7016	SF142B	TIMES	3.95	3.45	3.15
MC7024	SFT142	TIMES	5.85	4.95	4.60
MC7017	SF214	TIMES	4.25	3.90	3.70
MC7115	T-FLEX 402	TIMES	3.10	3.00	2.90
MC7021	T-FLEX 405	TIMES	1.80	1.76	1.70
MC7146	LMR-100A-PVC	TIMES	.39	.39	.39
MC7147	LMR-195	TIMES	.46	.46	.46
MC7148	LMR-200	TIMES	.46	.46	.46
MC7149	LMR-240	TIMES	.59	.59	.59
MC7150	LMR-300	TIMES	.69	.69	.69
MC7151	LMR-400	TIMES	.83	.83	.83
MC7152	LMR-500	TIMES	1.35	1.35	1.35
MC7153	LMR-600	TIMES	1.61	1.61	1.61

*ENVIROFLEX

**DOUBLE BRAID

TEST & MEASUREMENT CABLES

Outstanding Features

- Applicable up to 18.0 GHz
- Low insertion loss
- Excellent VSWR
- Unique loss stability
- There is no cable spring back during measurement procedures; the assembly stays in position



ELECTRICAL SPECIFICATIONS

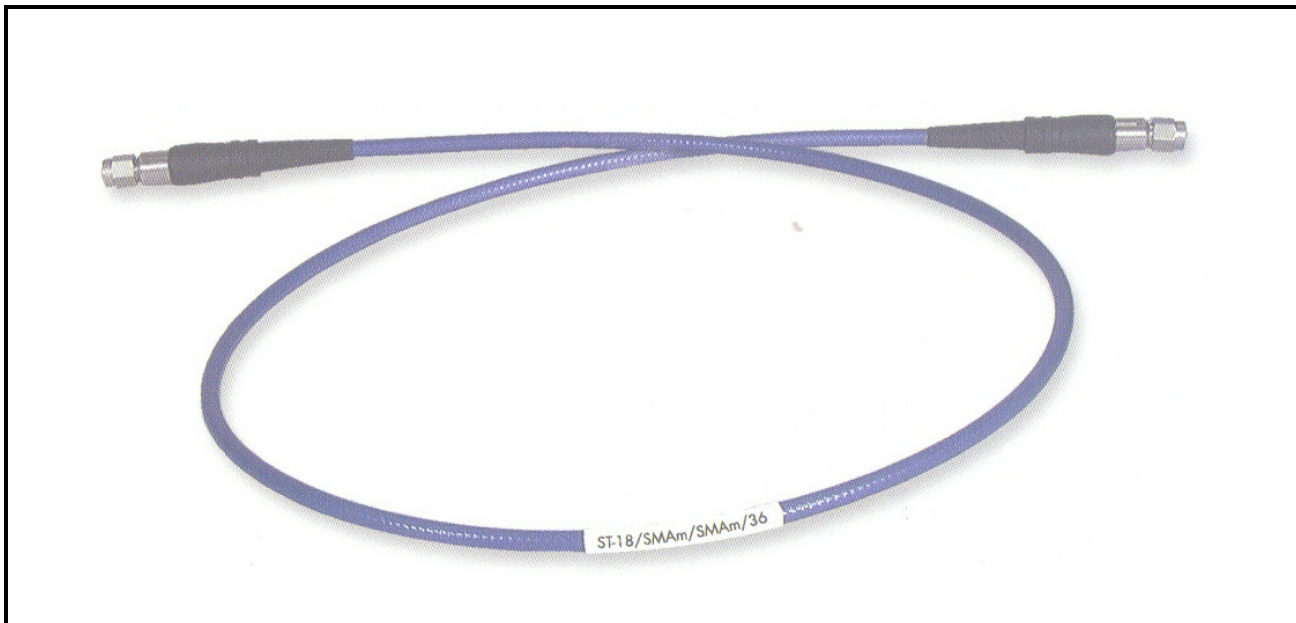
Impedance	50 Ohm				
Operating frequency	18 Ghz				
Velocity of propagation	77 %				
Capacitance	87 pF/m / 26.5 pF/ft				
Time delay	4.3 ns/m / 1.31 ns/ft				
Insulation resistance	> 5 x 10 ³ Mega Ohm				
Dielectric withstand voltage	2500 V rms				
Screening effectiveness	> 90 dB				
	Up to 2.0 Ghz	2.01 - 4.0 Ghz	4.01 - 6.0 Ghz	6.01 - 12.0 Ghz	12.01 - 18.0 Ghz
Power handling, 25°C, sea level (W)	>391	>277	>225	>160	>131
Return loss (dB)	>30	>28	>25	>21	>19
Insertion loss (dB)	see table	see table	see table	see table	see table
Insertion loss stability vs shaking (dB)	<0.03	<0.03	<0.03	<0.03	<0.03
Insertion loss stability vs bending (dB)	<0.03	<0.04	<0.04	<0.05	<0.05
Insertion loss stability vs torsion (dB)	<0.03	<0.04	<0.04	<0.05	<0.05

PRODUCT SPECIFIC DATA

Model #	Description	Assembly length (ref. plane to ref. plane)	Weight	Insertion loss				
				up to 2.0 GHz	2.01-4.0 GHz	4.01-6.0 GHz	6.01-12.0 GHz	12.01-18.0 GHz
MC9088	ST-18/SMAm/SMAm/12	305mm / 12inch	56 gram	<0.25dB	<0.35dB	<0.55dB	<0.65dB	<0.80dB
MC9089	ST-18/Nm/Nm/12	305mm / 12inch	86 gram	<0.25dB	<0.35dB	<0.55dB	<0.65dB	<0.80dB
MC9090	ST-18/SMAm/Nm/12	305mm / 12inch	68 gram	<0.25dB	<0.35dB	<0.55dB	<0.65dB	<0.80dB
MC9091	ST-18/SMAm/SMAm/18	457mm / 18inch	62 gram	<0.35dB	<0.45dB	<0.58dB	<0.82dB	<1.00dB
MC9092	ST-18/Nm/Nm/18	457mm / 18inch	92 gram	<0.35dB	<0.45dB	<0.58dB	<0.82dB	<1.00dB
MC9093	ST-18/SMAm/Nm/18	457mm / 18inch	63 gram	<0.35dB	<0.45dB	<0.58dB	<0.82dB	<1.00dB
MC9094	ST-18/SMAm/SMAm/24	609mm / 24inch	68 gram	<0.40dB	<0.58dB	<0.70dB	<1.00dB	<1.25dB
MC9095	ST-18/Nm/Nm/24	609mm / 24inch	98 gram	<0.40dB	<0.58dB	<0.70dB	<1.00dB	<1.25dB
MC9096	ST-18/SMAm/Nm/24	609mm / 24inch	79 gram	<0.40dB	<0.58dB	<0.70dB	<1.00dB	<1.25dB
MC9097	ST-18/SMAm/SMAm/36	914mm / 36inch	68 gram	<0.48dB	<0.68dB	<0.84dB	<1.21dB	<1.51dB
MC9098	ST-18/Nm/Nm/36	914mm / 36inch	110 gram	<0.48dB	<0.68dB	<0.84dB	<1.21dB	<1.51dB
MC9099	ST-18/SMAm/Nm/36	914mm / 36inch	90 gram	<0.48dB	<0.68dB	<0.84dB	<1.21dB	<1.51dB
MC9100	ST-18/SMAm/SMAm/48	1219mm / 48inch	80 gram	<0.61dB	<0.88dB	<1.09dB	<1.57dB	<1.95dB
MC9101	ST-18/Nm/Nm/48	1219mm / 48inch	122 gram	<0.61dB	<0.88dB	<1.09dB	<1.57dB	<1.95dB
MC9102	ST-18/SMAm/Nm/48	1219mm / 48inch	101 gram	<0.61dB	<0.88dB	<1.09dB	<1.57dB	<1.95dB
MC9103	ST-18/SMAm/SMAm/60	1524mm / 60 inch	96 gram	<0.74dB	<1.08dB	<1.88dB	<1.93dB	<2.4dB
MC9104	ST-18/Nm/Nm/60	1524mm / 60 inch	134 gram	<0.74dB	<1.08dB	<1.88dB	<1.93dB	<2.4dB
MC9105	ST-18/SMAm/Nm/60	1524mm / 60 inch	112 gram	<0.74dB	<1.08dB	<1.88dB	<1.93dB	<2.4dB
MC9106	ST-18/SMAm/SMAm/72	1829mm / 72inch	108 gram	<0.89dB	<1.28dB	<1.58dB	<2.29dB	<2.85dB
MC9107	ST-18/Nm/Nm/72	1829mm / 72inch	157 gram	<0.89dB	<1.28dB	<1.58dB	<2.29dB	<2.85dB
MC9108	ST-18/SMAm/Nm/72	1829mm / 72inch	134 gram	<0.89dB	<1.28dB	<1.58dB	<2.29dB	<2.85dB

<u>MODEL#</u>	<u>DESCRIPTION</u>	<u>1-24</u>	<u>25-49</u>	<u>50-99</u>	<u>100+</u>
MC9088	ST18/SMAm/SMAm/12	126.40	124.00	122.00	120.00
MC9089	ST18/Nm/Nm/12	220.00	188.00	186.00	184.00
MC9090	ST18/SMAm/Nm/12	190.00	162.00	160.00	158.00
MC9091	ST18/SMAm/SMAm/18	128.40	126.00	124.00	122.00
MC9092	ST18/Nm/Nm/18	222.00	190.00	188.00	186.00
MC9093	ST18/SMAm/Nm/18	190.00	162.00	160.00	158.00
MC9094	ST18/SMAm/SMAm/24	130.40	128.00	126.00	124.00
MC9095	ST18/Nm/Nm/24	224.00	192.00	190.00	188.00
MC9096	ST18/SMAm/Nm/24	190.00	162.00	160.00	158.00
MC9097	ST18/SMAm/SMAm/36	132.40	130.15	127.55	124.95
MC9098	ST18/Nm/Nm/36	226.80	194.60	192.00	190.00
MC9099	ST18/SMAm/Nm/36	194.25	166.35	164.00	162.00
MC9100	ST18/SMAm/SMAm/48	161.05	138.05	135.00	132.00
MC9101	ST18/Nm/Nm/48	237.20	203.20	201.00	199.00
MC9102	ST18/SMAm/Nm/48	202.00	173.00	171.00	169.00
MC9103	ST18/SMAm/SMAm/60	161.05	138.05	135.00	132.00
MC9104	ST18/Nm/Nm/60	242.00	208.00	203.00	201.00
MC9105	ST18/SMAm/Nm/60	211.00	182.00	180.00	178.00
MC9106	ST18/SMAm/SMAm/72	161.05	138.00	135.00	132.00
MC9107	ST18/Nm/Nm/72	256.00	219.50	217.00	215.00
MC9108	ST18/SMAm/Nm/72	220.00	190.00	188.00	186.00

SMAm = SMA Straight Cable Plug
Nm = N Type Straight Cable Plug





RG58C/U COAX

<u>MODEL#</u>	<u>LENGTH</u>	<u>1-24</u>	<u>25-49</u>	<u>50-99</u>	<u>100+</u>
MC9109-12	12"	13.20	12.30	11.35	10.55
MC9109-18	18"	13.40	12.40	11.50	10.70
MC9109-24	24"	13.55	12.60	11.65	10.85
MC9109-30	30"	13.70	12.75	11.80	11.00
MC9109-36	36"	13.90	12.90	11.95	11.10
MC9109-48	48"	14.20	13.20	12.25	11.40
MC9109-60	60"	14.55	13.55	12.50	11.65
MC9109-72	72"	14.90	13.85	12.80	11.90
MC9109-84	84"	15.25	14.15	13.10	12.20
MC9109-96	96"	15.60	14.50	13.40	12.45
MC9109-108	108"	15.90	14.80	13.70	12.75
MC9109-120	120"	16.25	15.10	14.00	13.00
MC9109-144	144"	16.95	15.75	14.55	13.55
MC9109-XX	ANY	PRICE UPON REQUEST			

RG142B/U COAX, DOUBLE SHIELDED

<u>MODEL#</u>	<u>LENGTH</u>	<u>1-24</u>	<u>25-49</u>	<u>50-99</u>	<u>100+</u>
MC9110-12	12"	22.00	20.43	18.93	17.63
MC9110-24	24"	24.75	23.00	21.31	19.81
MC9110-36	36"	27.50	25.56	23.63	22.00
MC9110-48	48"	30.25	28.13	26.00	24.19
MC9110-60	60"	33.00	30.69	28.38	26.38
MC9110-72	72"	35.75	33.25	30.75	28.63
MC9110-XX	ANY	PRICE UPON REQUEST			

RG174A/U COAX

<u>MODEL#</u>	<u>LENGTH</u>	<u>1-24</u>	<u>25-49</u>	<u>50-99</u>	<u>100+</u>
MC9111-12	12"	17.60	16.35	15.15	14.10
MC9111-24	24"	17.80	16.55	15.35	14.25
MC9111-36	36"	18.05	16.80	15.50	14.45
MC9111-48	48"	18.25	17.00	15.70	14.60
MC9111-60	60"	18.50	17.20	15.90	14.80
MC9111-72	72"	18.70	17.40	16.10	14.95
MC9111-84	84"	18.90	17.60	16.25	15.15
MC9111-96	96"	19.15	17.80	16.45	15.30
MC9111-108	108"	19.35	18.00	16.65	15.50
MC9111-120	120"	19.60	18.20	16.85	15.65
MC9111-144	144"	19.80	18.40	17.05	15.85
MC9111-XX	ANY	PRICE UPON REQUEST			

RG223/U COAX, DOUBLE SHIELDED

<u>MODEL#</u>	<u>LENGTH</u>	<u>1-24</u>	<u>25-49</u>	<u>50-99</u>	<u>100+</u>
MC9112-12	12"	22.00	20.43	18.93	17.63
MC9112-24	24"	23.38	21.75	20.13	18.69
MC9112-36	36"	24.75	23.00	21.31	19.81
MC9112-48	48"	26.13	24.31	22.44	20.88
MC9112-60	60"	27.50	25.56	23.63	22.00
MC9112-72	72"	28.88	26.88	23.56	23.12
MC9112-84	84"	30.25	28.13	26.00	24.19
MC9112-96	96"	31.63	29.44	27.19	25.31
MC9112-108	108"	33.00	30.69	28.38	26.38
MC9112-120	120"	34.38	32.00	29.56	27.50
MC9112-144	144"	35.75	33.25	30.75	28.63
MC9112-XX	ANY	PRICE UPON REQUEST			

RG316/U COAX

<u>MODEL#</u>	<u>LENGTH</u>	<u>1-24</u>	<u>25-49</u>	<u>50-99</u>	<u>100+</u>
MC9113-12	12"	17.60	16.35	15.15	14.10
MC9113-24	24"	19.80	18.40	17.05	15.85
MC9113-36	36"	22.00	20.45	18.90	17.60
MC9113-48	48"	24.20	22.50	20.80	19.35
MC9113-60	60"	26.40	24.55	22.70	21.10
MC9113-72	72"	28.60	26.60	24.60	22.90
MC9113-XX	ANY	PRICE UPON REQUEST			

RG400/U COAX, DOUBLE SHIELDED

<u>MODEL#</u>	<u>LENGTH</u>	<u>1-24</u>	<u>25-49</u>	<u>50-99</u>	<u>100+</u>
MC9114-12	12"	17.60	16.35	15.15	14.10
MC9114-24	24"	19.80	18.40	17.05	15.85
MC9114-36	36"	22.00	20.45	18.90	17.60
MC9114-48	48"	24.20	22.50	20.80	19.35
MC9114-60	60"	26.40	24.55	22.70	21.10
MC9114-72	72"	28.60	26.60	24.60	22.90
MC9114-XX	ANY	PRICE UPON REQUEST			

TIMES LMR-240

<u>MODEL#</u>	<u>LENGTH</u>	<u>1-24</u>	<u>25-49</u>	<u>50-99</u>	<u>100+</u>
MC9449-12	12"	22.81	21.67	20.58	19.55
MC9449-24	24"	23.46	22.90	21.17	20.11
MC9449-36	36"	24.11	22.90	21.75	20.67
MC9449-48	48"	24.76	23.52	22.34	21.22
MC9449-60	60"	25.41	24.14	22.93	21.79
MC9449-72	72"	26.06	24.76	23.52	22.34
MC9449-XX	ANY	PRICE UPON REQUEST			



RG58C/U COAX

<u>MODEL#</u>	<u>LENGTH</u>	<u>1-24</u>	<u>25-49</u>	<u>50-99</u>	<u>100+</u>
MC9115-12	12"	20.90	19.45	17.95	16.70
MC9115-24	24"	21.25	19.75	18.25	17.00
MC9115-36	36"	21.60	20.05	18.55	17.25
MC9115-48	48"	21.90	20.40	18.85	17.55
MC9115-60	60"	22.25	20.70	19.15	17.80
MC9115-72	72"	22.60	21.00	19.45	18.10
MC9115-XX	ANY	PRICE UPON REQUEST			

RG316/U COAX

<u>MODEL#</u>	<u>LENGTH</u>	<u>1-24</u>	<u>25-49</u>	<u>50-99</u>	<u>100+</u>
MC9120-12	12"	29.70	27.60	25.55	23.75
MC9120-24	24"	30.50	28.35	26.25	22.00
MC9120-36	36"	31.30	29.10	26.90	25.05
MC9120-48	48"	32.10	29.85	27.60	25.70
MC9120-60	60"	32.90	30.60	28.30	26.30
MC9120-72	72"	33.70	31.35	29.00	26.95
MC9120-XX	ANY	PRICE UPON REQUEST			

RG142B/U COAX, DOUBLE SHIELDED

<u>MODEL#</u>	<u>LENGTH</u>	<u>1-24</u>	<u>25-49</u>	<u>50-99</u>	<u>100+</u>
MC9116-12	12"	34.38	32.00	29.56	27.50
MC9116-24	24"	37.13	34.50	31.94	29.69
MC9116-36	36"	39.87	37.06	34.31	31.88
MC9116-48	48"	42.63	39.63	36.69	34.13
MC9116-60	60"	45.38	42.19	39.00	36.31
MC9116-72	72"	48.13	44.75	41.38	38.50
MC9116-XX	ANY	PRICE UPON REQUEST			

RG316-DS COAX, DOUBLE SHIELDED

<u>MODEL#</u>	<u>LENGTH</u>	<u>1-24</u>	<u>25-49</u>	<u>50-99</u>	<u>100+</u>
MC9121-12	12"	37.40	34.80	32.15	29.90
MC9121-24	24"	39.40	36.65	33.90	31.50
MC9121-36	36"	41.40	38.50	35.60	33.10
MC9121-48	48"	43.40	40.35	37.30	34.70
MC9121-60	60"	45.40	42.20	39.05	36.30
MC9121-72	72"	47.40	44.10	40.75	37.90
MC9121-XX	ANY	PRICE UPON REQUEST			

RG174A/U COAX

<u>MODEL#</u>	<u>LENGTH</u>	<u>1-24</u>	<u>25-49</u>	<u>50-99</u>	<u>100+</u>
MC9117-12	12"	28.60	26.60	24.60	22.90
MC9117-24	24"	28.80	26.80	24.80	23.05
MC9117-36	36"	29.05	27.00	24.95	23.25
MC9117-48	48"	29.25	27.20	25.15	23.40
MC9117-60	60"	29.50	27.40	25.35	23.60
MC9117-72	72"	29.70	27.60	25.55	23.75
MC9117-XXX	ANY	PRICE UPON REQUEST			

RG400/U COAX, DOUBLE SHIELDED

<u>MODEL#</u>	<u>LENGTH</u>	<u>1-24</u>	<u>25-49</u>	<u>50-99</u>	<u>100+</u>
MC9122-12	12"	27.50	25.60	23.65	22.00
MC9122-24	24"	29.70	27.60	25.55	23.75
MC9122-36	36"	31.90	29.65	27.45	25.50
MC9122-48	48"	34.10	31.70	29.35	27.30
MC9122-60	60"	36.30	33.75	31.20	29.05
MC9122-72	72"	38.50	35.80	33.10	30.80
MC9122-XX	ANY	PRICE UPON REQUEST			

RG223/U COAX, DOUBLE SHIELDED

<u>MODEL#</u>	<u>LENGTH</u>	<u>1-24</u>	<u>25-49</u>	<u>50-99</u>	<u>100+</u>
MC9119-12	12"	33.00	30.69	28.38	26.38
MC9119-24	24"	34.38	32.00	29.56	27.50
MC9119-36	36"	35.75	33.25	30.75	28.63
MC9119-48	48"	37.13	34.50	31.94	29.69
MC9119-60	60"	38.50	35.81	33.13	30.81
MC9119-72	72"	39.88	37.06	34.31	31.88
MC9119-XX	ANY	PRICE UPON REQUEST			

TIMES LMR-240

<u>MODEL#</u>	<u>LENGTH</u>	<u>1-24</u>	<u>25-49</u>	<u>50-99</u>	<u>100+</u>
MC9448-12	12"	26.20	24.89	23.65	22.46
MC9448-24	24"	26.85	25.50	24.23	23.02
MC9448-36	36"	27.50	26.13	24.82	23.58
MC9448-48	48"	28.15	26.74	25.40	24.14
MC9448-60	60"	28.80	27.36	25.99	24.69
MC9448-72	72"	29.45	27.98	26.58	25.25
MC9448-XX	ANY	PRICE UPON REQUEST			



RG58C/U COAX

<u>MODEL#</u>	<u>LENGTH</u>	<u>1-24</u>	<u>25-49</u>	<u>50-99</u>	<u>100+</u>
MC9124-12	12"	20.90	19.45	17.95	16.70
MC9124-24	24"	21.25	19.75	18.25	17.00
MC9124-36	36"	21.60	20.05	18.55	17.25
MC9124-48	48"	21.90	20.40	18.85	17.55
MC9124-60	60"	22.25	20.70	19.15	17.80
MC9124-72	72"	22.60	21.00	19.45	18.10
MC9124-XX	ANY	PRICE UPON REQUEST			

RG316/U COAX

<u>MODEL#</u>	<u>LENGTH</u>	<u>1-24</u>	<u>25-49</u>	<u>50-99</u>	<u>100+</u>
MC9129-12	12"	28.60	26.60	24.60	22.90
MC9129-24	24"	29.40	27.35	25.30	23.50
MC9129-36	36"	30.20	28.10	25.95	24.15
MC9129-48	48"	31.00	28.85	26.65	24.80
MC9129-60	60"	31.80	29.55	27.35	25.45
MC9129-72	72"	32.60	30.30	28.05	26.10
MC9129-XX	ANY	PRICE UPON REQUEST			

RG142B/U COAX, DOUBLE SHIELDED

<u>MODEL#</u>	<u>LENGTH</u>	<u>1-24</u>	<u>25-49</u>	<u>50-99</u>	<u>100+</u>
MC9125-12	12"	34.38	32.00	29.56	27.50
MC9125-24	24"	37.13	34.50	31.94	29.69
MC9125-36	36"	39.88	37.06	34.31	31.88
MC9125-48	48"	42.63	39.63	36.69	34.13
MC9125-60	60"	45.38	42.19	39.00	36.31
MC9125-72	72"	48.13	44.75	41.38	38.50
MC9125-XX	ANY	PRICE UPON REQUEST			

RG316-DS COAX, DOUBLE SHIELDED

<u>MODEL#</u>	<u>LENGTH</u>	<u>1-24</u>	<u>25-49</u>	<u>50-99</u>	<u>100+</u>
MC9130-12	12"	37.40	34.80	32.15	29.90
MC9130-24	24"	39.40	36.65	33.90	31.50
MC9130-36	36"	41.40	38.50	35.60	33.10
MC9130-48	48"	43.40	40.35	37.30	34.70
MC9130-60	60"	45.40	42.20	39.05	36.30
MC9130-72	72"	47.40	44.10	40.75	37.90
MC9130-XX	ANY	PRICE UPON REQUEST			

RG174A/U COAX

<u>MODEL#</u>	<u>LENGTH</u>	<u>1-24</u>	<u>25-49</u>	<u>50-99</u>	<u>100+</u>
MC9126-12	12"	28.60	26.60	24.60	22.90
MC9126-24	24"	28.80	26.80	24.80	23.05
MC9126-36	36"	29.05	27.00	24.95	23.25
MC9126-48	48"	29.25	27.20	25.15	23.40
MC9126-60	60"	29.50	27.40	25.35	23.60
MC9126-72	72"	29.70	27.60	25.55	23.75
MC9126-XX	ANY	PRICE UPON REQUEST			

RG400/U COAX, DOUBLE SHIELDED

<u>MODEL#</u>	<u>LENGTH</u>	<u>1-24</u>	<u>25-49</u>	<u>50-99</u>	<u>100+</u>
MC9131-12	12"	27.50	25.60	23.65	22.00
MC9131-24	24"	29.70	27.60	25.55	23.75
MC9131-36	36"	31.90	29.65	27.45	22.50
MC9131-48	48"	34.10	31.70	29.35	27.30
MC9131-60	60"	36.30	33.75	31.20	29.05
MC9131-72	72"	38.50	35.80	33.10	30.80
MC9131-XX	ANY	PRICE UPON REQUEST			

RG223/U COAX, DOUBLE SHIELDED

<u>MODEL#</u>	<u>LENGTH</u>	<u>1-24</u>	<u>25-49</u>	<u>50-99</u>	<u>100+</u>
MC9128-12	12"	31.63	29.44	27.19	25.31
MC9128-24	24"	33.00	30.69	28.38	26.38
MC9128-36	36"	34.38	32.00	29.56	27.50
MC9128-48	48"	35.75	33.25	30.75	28.63
MC9128-60	60"	37.13	34.50	31.94	29.69
MC9128-72	72"	38.50	35.81	33.13	30.81
MC9128-XX	ANY	PRICE UPON REQUEST			

TIMES LMR-240

<u>MODEL#</u>	<u>LENGTH</u>	<u>1-24</u>	<u>25-49</u>	<u>50-99</u>	<u>100+</u>
MC9447-12	12"	24.75	23.51	22.34	21.22
MC9447-24	24"	25.40	24.13	22.92	21.77
MC9447-36	36"	26.05	24.75	23.51	22.33
MC9447-48	48"	26.70	25.37	24.10	22.90
MC9447-60	60"	27.35	25.98	24.68	23.45
MC9447-72	72"	28.00	26.60	25.27	24.00
MC9447-XX	ANY	PRICE UPON REQUEST			



RG58C/U COAX

<u>MODEL#</u>	<u>LENGTH</u>	<u>1-24</u>	<u>25-49</u>	<u>50-99</u>	<u>100+</u>
MC9132-12	12"	17.60	16.35	15.15	14.10
MC9132-24	24"	17.95	16.70	15.45	14.35
MC9132-36	36"	18.30	17.00	15.70	14.60
MC9132-48	48"	18.60	17.30	16.00	14.90
MC9132-60	60"	18.95	17.65	16.30	15.15
MC9132-72	72"	19.30	17.95	16.60	15.45
MC9132-XX	ANY	PRICE UPON REQUEST			

RG316/U COAX

<u>MODEL#</u>	<u>LENGTH</u>	<u>1-24</u>	<u>25-49</u>	<u>50-99</u>	<u>100+</u>
MC9136-12	12"	29.70	27.60	25.55	23.75
MC9136-24	24"	30.50	28.35	26.25	24.40
MC9136-36	36"	31.30	29.10	26.90	25.05
MC9136-48	48"	32.10	29.85	27.60	25.70
MC9136-60	60"	32.90	30.60	28.30	26.30
MC9136-72	72"	33.70	31.35	29.00	26.95
MC9136-XX	ANY	PRICE UPON REQUEST			

RG142B/U COAX, DOUBLE SHIELDED

<u>MODEL#</u>	<u>LENGTH</u>	<u>1-24</u>	<u>25-49</u>	<u>50-99</u>	<u>100+</u>
MC9133-12	12"	28.88	26.88	24.81	23.13
MC9133-24	24"	31.63	29.44	27.19	25.31
MC9133-36	36"	34.38	32.00	29.56	27.50
MC9133-48	48"	37.13	34.50	31.94	29.69
MC9133-60	60"	39.88	37.06	34.31	31.88
MC9133-72	72"	42.63	39.63	36.69	34.13
MC9133-XX	ANY	PRICE UPON REQUEST			

RG316-DS COAX, DOUBLE SHIELDED

<u>MODEL#</u>	<u>LENGTH</u>	<u>1-24</u>	<u>25-49</u>	<u>50-99</u>	<u>100+</u>
MC9137-6	6"	33.00	30.70	28.40	26.40
MC9137-12	12"	34.00	31.60	29.25	27.20
MC9137-18	18"	35.00	32.55	30.10	28.00
MC9137-24	24"	36.00	33.50	30.95	28.80
MC9137-36	36"	38.00	35.35	32.70	30.40
MC9137-48	48"	40.00	37.20	34.40	32.00
MC9137-60	60"	42.00	39.05	36.10	33.60
MC9137-72	72"	44.00	40.90	37.85	35.20
MC9137-XX	ANY	PRICE UPON REQUEST			

RG174A/U COAX

<u>MODEL#</u>	<u>LENGTH</u>	<u>1-24</u>	<u>25-49</u>	<u>50-99</u>	<u>100+</u>
MC9134-6	6"	28.60	26.60	24.60	22.90
MC9134-12	12"	28.70	26.70	24.70	23.00
MC9134-18	18"	28.80	26.80	24.80	23.05
MC9134-24	24"	28.95	26.90	24.90	23.15
MC9134-36	36"	29.15	27.10	25.05	23.30
MC9134-48	48"	29.35	27.30	25.25	23.50
MC9134-60	60"	29.60	27.50	25.45	23.65
MC9134-72	72"	29.80	27.70	25.65	23.85
MC9134-XX	ANY	PRICE UPON REQUEST			

RG400/U COAX, DOUBLE SHIELDED

<u>MODEL#</u>	<u>LENGTH</u>	<u>1-24</u>	<u>25-49</u>	<u>50-99</u>	<u>100+</u>
MC9138-12	12"	23.10	21.50	19.85	18.50
MC9138-24	24"	25.30	23.55	21.75	20.25
MC9138-36	36"	27.50	25.60	23.65	22.00
MC9138-48	48"	29.70	27.60	25.55	23.75
MC9138-60	60"	31.90	29.65	27.45	25.50
MC9138-72	72"	34.10	31.70	29.35	27.30
MC9138-XX	ANY	PRICE UPON REQUEST			

RG223/U COAX

<u>MODEL#</u>	<u>LENGTH</u>	<u>1-24</u>	<u>25-49</u>	<u>50-99</u>	<u>100+</u>
MC9135-12	12"	19.80	18.40	17.05	15.85
MC9135-24	24"	20.90	19.45	17.95	16.70
MC9135-36	36"	22.00	20.45	18.90	17.60
MC9135-48	48"	23.10	21.50	19.85	18.50
MC9135-60	60"	24.20	22.50	20.80	19.35
MC9135-72	72"	25.30	23.50	21.75	20.25
MC9135-XX	ANY	PRICE UPON REQUEST			

TIMES LMR-240

<u>MODEL#</u>	<u>LENGTH</u>	<u>1-24</u>	<u>25-49</u>	<u>50-99</u>	<u>100+</u>
MC9446-12	12"	24.97	23.72	22.54	21.40
MC9446-24	24"	25.62	24.34	23.12	21.97
MC9446-36	36"	26.27	24.96	23.71	22.52
MC9446-48	48"	26.92	25.57	24.30	23.08
MC9446-60	60"	27.57	26.19	24.88	23.64
MC9446-72	72"	28.22	26.81	25.47	24.20
MC9446-XX	ANY	PRICE UPON REQUEST			

BNC MALE TO SMB MALE



RG174A/U COAX

<u>MODEL#</u>	<u>LENGTH</u>	<u>1-24</u>	<u>25-49</u>	<u>50-99</u>	<u>100+</u>
MC9139-12	12"	20.90	19.45	17.95	16.70
MC9139-24	24"	21.10	19.65	18.15	16.90
MC9139-36	36"	21.35	19.85	18.35	17.05
MC9139-48	48"	21.55	20.05	18.55	17.25
MC9139-60	60"	21.80	20.25	18.75	17.40
MC9139-72	72"	22.00	20.45	18.90	17.60
MC9139-XX	ANY	PRICE UPON REQUEST			

RG316/U COAX

<u>MODEL#</u>	<u>LENGTH</u>	<u>1-24</u>	<u>25-49</u>	<u>50-99</u>	<u>100+</u>
MC9140-12	12"	20.90	19.45	17.95	16.70
MC9140-24	24"	21.70	20.20	18.65	17.35
MC9140-36	36"	22.50	20.95	19.35	18.00
MC9140-48	48"	23.30	21.65	20.05	18.65
MC9140-60	60"	24.10	22.40	20.75	19.30
MC9140-72	72"	24.90	23.15	21.40	19.90
MC9140-XX	ANY	PRICE UPON REQUEST			

RG316-DS COAX, DOUBLE SHIELDED

<u>MODEL#</u>	<u>LENGTH</u>	<u>1-24</u>	<u>25-49</u>	<u>50-99</u>	<u>100+</u>
MC9141-12	12"	34.10	31.70	29.35	27.30
MC9141-24	24"	36.10	33.55	31.05	28.90
MC9141-36	36"	38.10	35.45	32.75	30.50
MC9141-48	48"	40.10	37.30	34.50	32.10
MC9141-60	60"	42.10	39.15	36.20	33.70
MC9141-72	72"	44.10	41.00	37.95	35.30
MC9141-XX	ANY	PRICE UPON REQUEST			

BNC MALE TO SMC MALE



RG174A/U COAX

<u>MODEL#</u>	<u>LENGTH</u>	<u>1-24</u>	<u>25-49</u>	<u>50-99</u>	<u>100+</u>
MC9142-12	12"	20.90	19.45	17.95	16.70
MC9142-24	24"	21.10	19.65	18.15	16.90
MC9142-36	36"	21.35	19.85	18.35	17.05
MC9142-48	48"	21.55	20.05	18.55	17.25
MC9142-60	60"	21.80	20.25	18.75	17.40
MC9142-72	72"	22.00	20.45	18.90	17.60
MC9142-XX	ANY	PRICE UPON REQUEST			

RG316/U COAX

<u>MODEL#</u>	<u>LENGTH</u>	<u>1-24</u>	<u>25-49</u>	<u>50-99</u>	<u>100+</u>
MC9143-12	12"	20.90	19.45	17.95	16.70
MC9143-24	24"	21.70	20.20	18.65	17.35
MC9143-36	36"	22.50	20.95	19.35	18.00
MC9143-48	48"	23.30	21.65	20.05	18.65
MC9143-60	60"	24.10	22.40	20.75	19.30
MC9143-72	72"	24.90	23.15	21.40	19.90
MC9143-XX	ANY	PRICE UPON REQUEST			

RG316-DS COAX, DOUBLE SHIELDED

<u>MODEL#</u>	<u>LENGTH</u>	<u>1-24</u>	<u>25-49</u>	<u>50-99</u>	<u>100+</u>
MC9144-12	12"	34.10	31.70	29.35	27.30
MC9144-24	24"	36.10	33.55	31.05	28.90
MC9144-36	36"	38.10	35.45	32.75	30.50
MC9144-48	48"	40.10	37.30	34.50	32.10
MC9144-60	60"	42.10	39.15	36.20	33.70
MC9144-72	72"	44.10	41.00	37.95	35.30
MC9144-XX	ANY	PRICE UPON REQUEST			

SMA MALE RIGHT-ANGLE TO BNC MALE



RG58C/U COAX

<u>MODEL#</u>	<u>LENGTH</u>	<u>1-24</u>	<u>25-49</u>	<u>50-99</u>	<u>100+</u>
MC9145-6	6"	34.10	31.70	29.35	27.30
MC9145-12	12"	34.25	31.85	29.45	27.40
MC9145-18	18"	34.45	32.05	29.60	27.55
MC9145-24	24"	34.60	32.20	29.75	27.70
MC9145-36	36"	34.95	32.50	30.05	27.95
MC9145-48	48"	35.30	32.80	30.35	28.25
MC9145-60	60"	35.65	33.15	30.65	28.50
MC9145-72	72"	35.95	33.45	30.95	28.80
MC9145-XX	ANY	PRICE UPON REQUEST			

RG223/U COAX, DOUBLE SHIELDED

<u>MODEL#</u>	<u>LENGTH</u>	<u>1-24</u>	<u>25-49</u>	<u>50-99</u>	<u>100+</u>
MC9148-6	6"	44.00	40.94	37.81	35.19
MC9148-12	12"	44.69	41.56	38.44	35.75
MC9148-18	18"	45.38	42.19	39.00	36.31
MC9148-24	24"	46.06	42.81	39.63	36.88
MC9148-36	36"	47.44	44.13	40.81	37.94
MC9148-48	48"	48.81	45.38	42.00	39.06
MC9148-60	60"	50.19	46.69	43.19	40.13
MC9148-72	72"	51.56	47.94	44.38	41.25
MC9148-XX	ANY	PRICE UPON REQUEST			

RG142B/U COAX, DOUBLE SHIELDED

<u>MODEL#</u>	<u>LENGTH</u>	<u>1-24</u>	<u>25-49</u>	<u>50-99</u>	<u>100+</u>
MC9146-6	6"	44.00	40.94	37.81	22.69
MC9146-12	12"	45.38	42.19	39.00	36.31
MC9146-18	18"	46.75	43.50	40.19	37.38
MC9146-24	24"	48.13	44.75	41.38	38.50
MC9146-36	36"	50.88	47.31	43.75	40.69
MC9146-48	48"	53.63	49.88	46.13	42.88
MC9146-60	60"	56.38	52.44	48.50	45.13
MC9146-72	72"	59.13	55.00	50.88	47.31
MC9146-XX	ANY	PRICE UPON REQUEST			

RG316/U COAX

<u>MODEL#</u>	<u>LENGTH</u>	<u>1-24</u>	<u>25-49</u>	<u>50-99</u>	<u>100+</u>
MC9149-6	6"	33.00	30.70	28.40	26.40
MC9149-12	12"	33.40	31.05	28.70	26.70
MC9149-18	18"	33.80	31.45	29.05	27.05
MC9149-24	24"	34.20	31.80	29.40	27.35
MC9149-36	36"	35.00	32.55	30.10	28.00
MC9149-48	48"	35.80	33.30	30.80	28.65
MC9149-60	60"	36.60	34.05	31.50	29.30
MC9149-72	72"	37.40	34.80	32.15	29.90
MC9149-XX	ANY	PRICE UPON REQUEST			

RG174A/U, COAX

<u>MODEL#</u>	<u>LENGTH</u>	<u>1-24</u>	<u>25-49</u>	<u>50-99</u>	<u>100+</u>
MC9147-6	6"	34.10	31.70	29.35	27.30
MC9147-12	12"	34.20	31.80	29.40	27.35
MC9147-18	18"	34.30	31.90	29.50	27.45
MC9147-24	24"	34.45	32.00	29.60	27.55
MC9147-36	36"	34.65	32.20	29.80	27.70
MC9147-48	48"	34.85	32.45	30.00	27.90
MC9147-60	60"	35.10	32.65	30.20	28.05
MC9147-72	72"	35.30	32.85	30.35	28.25
MC9147-XX	ANY	PRICE UPON REQUEST			

RG400/U COAX, DOUBLE SHIELDED

<u>MODEL#</u>	<u>LENGTH</u>	<u>1-24</u>	<u>25-49</u>	<u>50-99</u>	<u>100+</u>
MC9150-6	6"	35.20	32.75	30.25	28.15
MC9150-12	12"	36.30	33.75	31.22	29.05
MC9150-18	18"	37.40	34.80	32.15	29.90
MC9150-24	24"	38.50	35.80	33.10	30.80
MC9150-36	36"	40.70	37.85	35.00	32.55
MC9150-48	48"	42.90	39.90	36.90	34.30
MC9150-60	60"	45.10	41.95	38.80	36.10
MC9150-72	72"	47.30	44.00	40.70	37.85
MC9150-XX	ANY	PRICE UPON REQUEST			



RG58C/U COAX

<u>MODEL#</u>	<u>LENGTH</u>	<u>1-24</u>	<u>25-49</u>	<u>50-99</u>	<u>100+</u>
MC9152-12	12"	22.00	20.45	18.90	17.60
MC9152-24	24"	22.35	20.80	19.20	17.85
MC9152-36	36"	22.70	21.10	19.50	18.15
MC9152-48	48"	23.00	21.40	19.80	18.40
MC9152-60	60"	23.35	21.70	20.10	18.70
MC9152-72	72"	23.70	22.05	20.40	18.95
MC9152-XX	ANY	PRICE UPON REQUEST			

RG223/U COAX, DOUBLE SHIELDED

<u>MODEL#</u>	<u>LENGTH</u>	<u>1-24</u>	<u>25-49</u>	<u>50-99</u>	<u>100+</u>
MC9157-12	12"	31.63	29.38	27.19	25.31
MC9157-24	24"	33.00	30.69	28.38	26.38
MC9157-36	36"	34.38	32.00	29.56	27.50
MC9157-48	48"	35.75	33.25	30.75	28.63
MC9157-60	60"	37.13	34.50	31.94	29.69
MC9157-72	72"	38.50	35.81	33.13	30.81
MC9157-XX	ANY	PRICE UPON REQUEST			

RG142B/U COAX, DOUBLE SHIELDED

<u>MODEL#</u>	<u>LENGTH</u>	<u>1-24</u>	<u>25-49</u>	<u>50-99</u>	<u>100+</u>
MC9153-12	12"	33.00	30.69	28.38	26.38
MC9153-24	24"	35.75	33.25	30.75	28.63
MC9153-36	36"	38.50	35.81	33.13	30.81
MC9153-48	48"	41.25	38.38	35.50	33.00
MC9153-60	60"	44.00	40.94	37.81	35.19
MC9153-72	72"	46.75	43.50	40.19	37.38
MC9153-XX	ANY	PRICE UPON REQUEST			

RG316/U COAX

<u>MODEL#</u>	<u>LENGTH</u>	<u>1-24</u>	<u>25-49</u>	<u>50-99</u>	<u>100+</u>
MC9158-12	12"	25.30	23.50	21.75	20.25
MC9158-24	24"	26.10	24.25	22.45	20.90
MC9158-36	36"	26.90	25.00	23.15	21.50
MC9158-48	48"	27.70	25.75	23.80	22.15
MC9158-60	60"	28.50	26.50	24.50	22.80
MC9158-72	72"	29.30	27.25	25.20	23.45
MC9158-XX	ANY	PRICE UPON REQUEST			

RG174A/U COAX

<u>MODEL#</u>	<u>LENGTH</u>	<u>1-24</u>	<u>25-49</u>	<u>50-99</u>	<u>100+</u>
MC9154-12	12"	25.30	23.55	21.75	20.25
MC9154-24	24"	25.50	23.75	21.95	20.40
MC9154-36	36"	25.75	23.95	22.15	20.60
MC9154-48	48"	25.95	24.15	22.35	20.75
MC9154-60	60"	26.20	24.35	22.50	20.95
MC9154-72	72"	26.40	24.55	22.70	21.10
MC9154-XX	ANY	PRICE UPON REQUEST			

RG400/U COAX, DOUBLE SHIELDED

<u>MODEL#</u>	<u>LENGTH</u>	<u>1-24</u>	<u>25-49</u>	<u>50-99</u>	<u>100+</u>
MC9159-12	12"	26.40	24.55	22.70	21.10
MC9159-24	24"	28.60	26.60	24.60	22.90
MC9159-36	36"	30.80	28.65	26.50	24.65
MC9159-48	48"	33.00	30.70	28.40	26.40
MC9159-60	60"	35.20	32.75	30.25	28.15
MC9159-72	72"	37.40	34.80	32.15	29.90
MC9159-XX	ANY	PRICE UPON REQUEST			

RG178B/U COAX

<u>MODEL#</u>	<u>LENGTH</u>	<u>1-24</u>	<u>25-49</u>	<u>50-99</u>	<u>100+</u>
MC9155-12	12"	42.90	39.90	36.90	34.30
MC9155-24	24"	43.70	40.65	37.60	34.95
MC9155-36	36"	44.50	41.40	38.25	35.60
MC9155-48	48"	45.30	42.15	38.95	36.25
MC9155-60	60"	46.10	42.85	39.65	36.90
MC9155-72	72"	46.90	43.60	40.35	37.50
MC9155-XX	ANY	PRICE UPON REQUEST			

TIMES LMR-240

<u>MODEL#</u>	<u>LENGTH</u>	<u>1-24</u>	<u>25-49</u>	<u>50-99</u>	<u>100+</u>
MC9445-12	12"	25.40	24.13	22.92	21.77
MC9445-24	24"	26.05	24.75	23.51	22.34
MC9445-36	36"	26.70	25.37	24.10	22.90
MC9445-48	48"	27.35	25.98	24.68	23.45
MC9445-60	60"	28.00	26.60	25.27	24.00
MC9445-72	72"	28.65	27.22	25.86	24.57
MC9445-XX	ANY	PRICE UPON REQUEST			



RG142B/U COAX, DOUBLE SHIELDED

<u>MODEL#</u>	<u>LENGTH</u>	<u>1-24</u>	<u>25-49</u>	<u>50-99</u>	<u>100+</u>
MC9400-6	6"	26.90	24.40	23.45	22.50
MC9400-12	12"	27.50	25.00	24.05	23.10
MC9400-18	18"	28.10	25.60	24.65	23.70
MC9400-24	24"	29.30	27.30	26.35	25.40
MC9400-36	36"	39.10	29.60	28.65	27.70
MC9400-48	48"	34.40	31.90	30.95	30.00
MC9400-60	60"	36.70	34.20	33.25	32.30
MC9400-72	72"	39.00	36.50	35.55	34.60
MC9400XX	ANY	PRICE UPON REQUEST			

RG178B/U COAX

<u>MODEL#</u>	<u>LENGTH</u>	<u>1-24</u>	<u>25-49</u>	<u>50-99</u>	<u>100+</u>
MC9401-06	6"	28.70	26.95	25.20	23.45
MC9401-12	12"	29.30	27.55	25.80	24.05
MC9401-18	18"	29.90	28.15	26.40	24.65
MC9401-24	24"	30.35	28.60	26.85	25.10
MC9401-36	36"	31.40	29.65	27.90	26.15
MC9401-48	48"	32.45	30.70	28.95	27.20
MC9401-60	60"	33.50	31.75	30.00	28.25
MC9401-72	72"	34.55	32.80	31.05	29.30
MC9401-XX	ANY	PRICE UPON REQUEST			

RG174A/U COAX

<u>MODEL#</u>	<u>LENGTH</u>	<u>1-24</u>	<u>25-49</u>	<u>50-99</u>	<u>100+</u>
MC9402-6	6"	23.40	22.60	21.40	20.25
MC9402-12	12"	24.35	23.55	22.35	21.20
MC9402-18	18"	25.30	24.50	23.30	22.15
MC9402-24	24"	26.25	25.45	24.25	23.10
MC9402-36	36"	27.20	26.40	25.20	24.05
MC9402-48	48"	28.15	27.35	26.15	25.00
MC9402-60	60"	29.10	28.30	27.10	25.95
MC9402-72	72"	30.05	29.25	28.05	26.90
MC9402-XX	ANY	PRICE UPON REQUEST			

RG223/U COAX, DOUBLE SHIELDED

<u>MODEL#</u>	<u>LENGTH</u>	<u>1-24</u>	<u>25-49</u>	<u>50-99</u>	<u>100+</u>
MC9403-6	6"	29.45	26.60	25.45	24.40
MC9403-12	12"	30.45	27.60	26.45	25.40
MC9403-18	18"	31.45	28.60	27.45	26.40
MC9403-24	24"	32.45	29.60	28.45	27.40
MC9403-36	36"	33.45	30.60	29.45	28.40
MC9403-48	48"	34.45	31.60	30.45	29.40
MC9403-60	60"	35.45	32.60	31.45	30.40
MC9403-72	72"	36.45	33.60	32.45	31.40
MC9403-XX	ANY	PRICE UPON REQUEST			

RG316/U COAX

<u>MODEL#</u>	<u>LENGTH</u>	<u>1-24</u>	<u>25-49</u>	<u>50-99</u>	<u>100+</u>
MC9404-6	6"	23.40	22.60	21.40	20.25
MC9404-12	12"	24.35	23.55	22.35	21.20
MC9404-18	18"	25.30	24.50	23.30	22.15
MC9404-24	24"	26.25	25.45	24.25	23.10
MC9404-36	36"	27.20	26.40	25.20	24.05
MC9404-48	48"	28.15	27.35	26.15	25.00
MC9404-60	60"	29.10	28.30	27.10	25.95
MC9404-72	72"	30.05	29.25	28.05	26.90
MC9404XX	ANY	PRICE UPON REQUEST			

RD316-DS COAX, DOUBLE SHIELDED

<u>MODEL#</u>	<u>LENGTH</u>	<u>1-24</u>	<u>25-49</u>	<u>50-99</u>	<u>100+</u>
MC9405-6	6"	29.00	27.25	25.50	23.75
MC9405-12	12"	29.80	28.05	26.30	24.55
MC9405-18	18"	30.60	28.85	27.10	25.35
MC9405-24	24"	31.40	29.65	27.90	26.15
MC9405-36	36"	32.20	30.45	28.70	26.95
MC9405-48	48"	33.00	31.25	29.50	27.75
MC9405-60	60"	33.80	32.05	30.30	28.55
MC9405-72	72"	34.60	32.85	31.10	29.35
MC9405-XX	ANY	PRICE UPON REQUEST			

RG400U COAX, DOUBLE SHIELDED

<u>MODEL#</u>	<u>LENGTH</u>	<u>1-24</u>	<u>25-49</u>	<u>50-99</u>	<u>100+</u>
MC9406-6	6"	29.45	26.60	25.45	24.40
MC9406-12	12"	30.45	27.60	26.45	25.40
MC9406-18	18"	31.45	28.60	27.45	26.40
MC9406-24	24"	32.45	29.60	28.45	27.40
MC9406-36	36"	33.45	30.60	29.45	28.40
MC9406-48	48"	34.45	31.60	30.45	29.40
MC9406-60	60"	35.45	32.60	31.45	30.40
MC9406-72	72"	36.45	33.60	32.45	31.40
MC9406-XX	ANY	PRICE UPON REQUEST			

TIMES LMR-240

<u>MODEL#</u>	<u>LENGTH</u>	<u>1-24</u>	<u>25-49</u>	<u>50-99</u>	<u>100+</u>
MC9444-12	12"	25.40	24.13	22.92	21.77
MC9444-24	24"	26.05	24.75	23.51	22.34
MC9444-36	36"	26.70	25.37	24.10	22.90
MC9444-48	48"	27.35	25.98	24.68	23.45
MC9444-60	60"	28.00	26.60	25.27	24.00
MC9444-72	72"	28.65	27.22	25.86	24.57
MC9444-XX	ANY	PRICE UPON REQUEST			

SMA MALE TO SMA MALE RIGHT-ANGLE



RG58C/U COAX

<u>MODEL#</u>	<u>LENGTH</u>	<u>1-24</u>	<u>25-49</u>	<u>50-99</u>	<u>100+</u>
MC9160-6	6"	35.20	32.75	30.25	28.15
MC9160-12	12"	35.35	32.90	30.40	28.30
MC9160-18	18"	35.55	33.05	30.55	28.45
MC9160-24	24"	35.70	33.20	30.70	28.55
MC9160-36	36"	36.05	33.55	31.00	28.85
MC9160-48	48"	36.40	33.85	31.30	29.10
MC9160-60	60"	36.75	34.15	31.60	29.40
MC9160-72	72"	37.05	34.50	31.90	29.65
MC9160-XX	ANY	PRICE UPON REQUEST			

RG223/U COAX, DOUBLE SHIELDED

<u>MODEL#</u>	<u>LENGTH</u>	<u>1-24</u>	<u>25-49</u>	<u>50-99</u>	<u>100+</u>
MC9164-6	6"	44.00	40.94	37.81	35.19
MC9164-12	12"	44.69	41.56	38.44	35.75
MC9164-18	18"	45.38	42.19	39.00	36.31
MC9164-24	24"	46.06	42.81	39.63	36.88
MC9164-36	36"	47.44	44.13	40.81	37.94
MC9164-48	48"	48.81	44.13	40.81	37.94
MC9164-60	60"	50.19	46.69	43.19	40.13
MC9164-72	72"	51.56	47.94	44.38	41.25
MC9164-XX	ANY	PRICE UPON REQUEST			

RG142B/U COAX, DOUBLE SHIELDED

<u>MODEL#</u>	<u>LENGTH</u>	<u>1-24</u>	<u>25-49</u>	<u>50-99</u>	<u>100+</u>
MC9161-6	6"	46.75	43.50	40.19	37.38
MC9161-12	12"	48.13	44.75	41.38	38.50
MC9161-18	18"	49.50	46.06	42.56	39.63
MC9161-24	24"	50.88	47.31	43.75	40.68
MC9161-36	36"	53.63	49.88	46.13	54.13
MC9161-48	48"	56.38	52.44	48.50	45.13
MC9161-60	60"	59.13	55.00	50.88	47.31
MC9161-72	72"	61.88	57.56	53.19	49.50
MC9161-XX	ANY	PRICE UPON REQUEST			

RG316/U COAX

<u>MODEL#</u>	<u>LENGTH</u>	<u>1-24</u>	<u>25-49</u>	<u>50-99</u>	<u>100+</u>
MC9165-6	6"	35.20	32.75	30.25	28.15
MC9165-12	12"	35.60	33.10	30.60	28.50
MC9165-18	18"	36.00	33.50	30.95	28.80
MC9165-24	24"	36.40	33.85	31.30	29.10
MC9165-36	36"	37.20	34.60	32.00	29.75
MC9165-48	48"	38.00	35.35	32.70	30.40
MC9165-60	60"	38.80	36.10	33.35	31.05
MC9165-72	72"	39.60	36.85	34.06	31.68
MC9165-XX	ANY	PRICE UPON REQUEST			

RG174A/U, COAX

<u>MODEL#</u>	<u>LENGTH</u>	<u>1-24</u>	<u>25-49</u>	<u>50-99</u>	<u>100+</u>
MC9162-6	6"	35.20	32.75	30.25	28.15
MC9162-12	12"	35.30	32.85	30.35	28.25
MC9162-18	18"	35.40	32.95	30.45	28.35
MC9162-24	24"	35.55	33.05	30.55	28.40
MC9162-36	36"	35.75	33.25	30.75	28.60
MC9162-48	48"	35.95	33.45	30.95	28.80
MC9162-60	60"	36.20	33.65	31.10	28.95
MC9162-72	72"	36.40	33.85	31.30	29.15
MC9162-XX	ANY	PRICE UPON REQUEST			

RG316-DS COAX, DOUBLE SHIELDED

<u>MODEL#</u>	<u>LENGTH</u>	<u>1-24</u>	<u>25-49</u>	<u>50-99</u>	<u>100+</u>
MC9166-6	6"	37.40	34.80	32.15	29.90
MC9166-12	12"	38.40	35.70	33.00	30.70
MC9166-18	18"	39.40	36.65	33.90	31.50
MC9166-24	24"	40.40	37.55	34.75	32.30
MC9166-36	36"	42.40	39.45	36.45	33.90
MC9166-48	48"	44.40	41.30	38.20	35.50
MC9166-60	60"	46.40	43.15	39.90	37.10
MC9166-72	72"	48.40	45.00	41.60	38.70
MC9166-XX	ANY	PRICE UPON REQUEST			

RG178B/U COAX

<u>MODEL#</u>	<u>LENGTH</u>	<u>1-24</u>	<u>25-49</u>	<u>50-99</u>	<u>100+</u>
MC9163-6	6"	48.40	45.00	41.60	38.70
MC9163-12	12"	48.80	45.40	41.95	39.05
MC9163-18	18"	49.20	45.75	42.30	39.35
MC9163-24	24"	49.60	46.15	42.65	39.70
MC9163-36	36"	50.40	46.85	43.35	40.30
MC9163-48	48"	51.20	47.60	44.05	40.95
MC9163-60	60"	52.00	48.35	44.70	41.60
MC9163-72	72"	52.80	49.10	45.40	42.25
MC9163-XX	ANY	PRICE UPON REQUEST			

RG400/U COAX, DOUBLE SHIELDED

<u>MODEL#</u>	<u>LENGTH</u>	<u>1-24</u>	<u>25-49</u>	<u>50-99</u>	<u>100+</u>
MC9167-6	6"	37.40	34.80	32.15	29.90
MC9167-12	12"	38.50	35.80	33.10	30.80
MC9167-18	18"	39.60	36.85	34.05	31.70
MC9167-24	24"	40.70	37.85	35.00	32.55
MC9167-36	36"	42.90	39.90	36.90	34.30
MC9167-48	48"	45.10	41.95	38.80	36.10
MC9167-60	60"	47.30	44.00	40.70	37.85
MC9167-72	72"	49.50	46.05	42.60	39.60
MC9167-XX	ANY	PRICE UPON REQUEST			



RG58C/U COAX

<u>MODEL#</u>	<u>LENGTH</u>	<u>1-24</u>	<u>25-49</u>	<u>50-99</u>	<u>100+</u>
MC9168-6	6"	37.40	34.80	32.15	29.90
MC9168-12	12"	37.55	34.95	32.30	30.05
MC9168-18	18"	37.75	35.10	32.45	30.20
MC9168-24	24"	37.90	35.25	32.60	30.35
MC9168-36	36"	38.25	35.55	32.90	30.60
MC9168-48	48"	38.60	35.90	33.20	30.85
MC9168-60	60"	38.95	36.20	33.50	31.15
MC9168-72	72"	39.25	36.50	33.75	31.40
MC9168-XX	ANY	PRICE UPON REQUEST			

RG223/U COAX, DOUBLE SHIELDED

<u>MODEL#</u>	<u>LENGTH</u>	<u>1-24</u>	<u>25-49</u>	<u>50-99</u>	<u>100+</u>
MC9173-6	6"	46.75	43.50	40.19	37.38
MC9173-12	12"	47.44	44.13	40.81	37.94
MC9173-18	18"	48.13	44.75	41.38	38.50
MC9173-24	24"	48.81	45.38	42.00	39.06
MC9173-36	36"	50.19	46.69	43.19	40.13
MC9173-48	48"	51.56	47.94	44.38	41.23
MC9173-60	60"	52.94	49.25	45.50	42.38
MC9173-72	72"	54.31	50.50	46.69	43.44
MC9173-XX	ANY	PRICE UPON REQUEST			

RG142B/U COAX, DOUBLE SHIELDED

<u>MODEL#</u>	<u>LENGTH</u>	<u>1-24</u>	<u>25-49</u>	<u>50-99</u>	<u>100+</u>
MC9169-6	6"	49.50	46.06	42.56	39.63
MC9169-12	12"	50.88	47.31	43.75	40.69
MC9169-18	18"	52.25	48.56	44.94	41.81
MC9169-24	24"	53.63	49.88	46.13	42.88
MC9169-36	36"	56.38	52.44	48.50	45.13
MC9169-48	48"	59.13	55.00	50.88	47.31
MC9169-60	60"	61.88	57.56	53.19	49.50
MC9169-72	72"	64.63	60.13	55.56	51.69
MC9169-XX	ANY	PRICE UPON REQUEST			

RG316/U COAX

<u>MODEL#</u>	<u>LENGTH</u>	<u>1-24</u>	<u>25-49</u>	<u>50-99</u>	<u>100+</u>
MC9174-6	6"	37.40	34.80	32.15	29.90
MC9174-12	12"	37.80	35.15	32.50	30.25
MC9174-18	18"	38.20	35.55	32.85	30.55
MC9174-24	24"	38.60	35.90	33.20	30.90
MC9174-36	36"	39.40	36.65	33.90	31.50
MC9174-48	48"	40.20	37.40	35.55	32.15
MC9174-60	60"	41.00	38.15	35.25	32.80
MC9174-72	72"	41.80	38.85	35.95	33.45
MC9174-XX	ANY	PRICE UPON REQUEST			

RG174A/U COAX

<u>MODEL#</u>	<u>LENGTH</u>	<u>1-24</u>	<u>25-49</u>	<u>50-99</u>	<u>100+</u>
MC9170-6	6"	37.40	34.80	32.15	29.90
MC9170-12	12"	37.55	34.95	32.30	30.05
MC9170-18	18"	37.75	35.10	32.45	30.20
MC9170-24	24"	37.90	35.25	32.60	30.35
MC9170-36	36"	38.25	35.55	32.90	30.60
MC9170-48	48"	38.60	35.90	33.20	30.85
MC9170-60	60"	38.95	36.20	33.50	31.15
MC9170-72	72"	39.25	36.50	33.75	31.40
MC9170-XX	ANY	PRICE UPON REQUEST			

RG316-DS COAX, DOUBLE SHIELDED

<u>MODEL#</u>	<u>LENGTH</u>	<u>1-24</u>	<u>25-49</u>	<u>50-99</u>	<u>100+</u>
MC9175-6	6"	39.60	36.85	34.05	31.70
MC9175-12	12"	40.60	37.75	34.90	32.50
MC9175-18	18"	41.60	38.70	35.80	33.30
MC9175-24	24"	42.60	39.60	36.65	34.10
MC9175-36	36"	44.60	41.50	38.35	35.70
MC9175-48	48"	46.60	43.35	40.10	37.30
MC9175-60	60"	48.60	45.20	41.80	38.90
MC9175-72	72"	50.60	47.05	43.50	40.50
MC9175-XX	ANY	PRICE UPON REQUEST			

RG178B/U COAX

<u>MODEL#</u>	<u>LENGTH</u>	<u>1-24</u>	<u>25-49</u>	<u>50-99</u>	<u>100+</u>
MC9171-6	6"	51.70	48.10	44.45	41.35
MC9171-12	12"	52.10	48.45	44.80	41.70
MC9171-18	18"	52.50	48.85	45.15	42.00
MC9171-24	24"	52.90	49.20	45.50	42.30
MC9171-36	36"	53.70	49.95	46.20	42.95
MC9171-48	48"	54.50	50.70	46.85	43.60
MC9171-60	60"	55.30	51.45	47.55	44.25
MC9171-72	72"	56.10	52.15	48.25	44.90
MC9171-XX	ANY	PRICE UPON REQUEST			

RG400/U COAX, DOUBLE SHIELDED

<u>MODEL#</u>	<u>LENGTH</u>	<u>1-24</u>	<u>25-49</u>	<u>50-99</u>	<u>100+</u>
MC9176-6	6"	39.60	36.85	34.05	31.70
MC9176-12	12"	40.70	37.85	35.00	32.55
MC9176-18	18"	41.80	38.85	35.95	33.45
MC9176-24	24"	42.90	39.90	36.90	34.30
MC9176-36	36"	45.10	41.95	38.80	36.10
MC9176-48	48"	47.30	44.00	40.70	37.85
MC9176-60	60"	49.50	46.05	42.55	39.60
MC9176-72	72"	51.70	48.10	44.45	41.35
MC9176-XX	ANY	PRICE UPON REQUEST			



RG58C/U COAX

<u>MODEL#</u>	<u>LENGTH</u>	<u>1-24</u>	<u>25-49</u>	<u>50-99</u>	<u>100+</u>
MC9178-6	6"	35.20	32.75	30.25	28.15
MC9178-12	12"	35.35	32.90	30.40	28.30
MC9178-18	18"	35.55	33.05	30.55	28.45
MC9178-24	24"	35.70	33.20	30.70	28.55
MC9178-36	36"	36.05	33.55	31.00	28.85
MC9178-48	48"	36.40	33.85	31.30	29.10
MC9178-60	60"	36.75	34.15	31.60	29.40
MC9178-72	72"	37.05	34.50	31.90	29.65
MC9178-XX	ANY	PRICE UPON REQUEST			

RG142B/U COAX, DOUBLE SHIELDED

<u>MODEL#</u>	<u>LENGTH</u>	<u>1-24</u>	<u>25-49</u>	<u>50-99</u>	<u>100+</u>
MC9179-6	6"	49.50	46.06	42.56	39.63
MC9179-12	12"	50.88	47.31	43.75	40.69
MC9179-18	18"	52.25	48.56	44.94	41.81
MC9179-24	24"	53.63	49.88	46.13	42.88
MC9179-36	36"	56.38	52.44	48.50	45.13
MC9179-48	48"	59.13	55.00	50.88	47.31
MC9179-60	60"	61.88	57.56	53.19	49.50
MC9179-72	72"	64.63	60.13	55.56	51.69
MC9179-XX	ANY	PRICE UPON REQUEST			

RG174A/U COAX

<u>MODEL#</u>	<u>LENGTH</u>	<u>1-24</u>	<u>25-49</u>	<u>50-99</u>	<u>100+</u>
MC9180-6	6"	37.40	34.80	32.15	29.90
MC9180-12	12"	37.55	34.95	32.30	30.05
MC9180-18	18"	37.75	35.10	32.45	30.20
MC9180-24	24"	37.90	35.25	32.60	30.35
MC9180-36	36"	38.25	35.55	32.90	30.60
MC9180-48	48"	38.60	35.90	33.20	30.85
MC9180-60	60"	38.95	36.20	33.50	31.15
MC9180-72	72"	39.25	36.50	33.75	31.40
MC9180-XX	ANY	PRICE UPON REQUEST			

RG223/U COAX, DOUBLE SHIELDED

<u>MODEL#</u>	<u>LENGTH</u>	<u>1-24</u>	<u>25-49</u>	<u>50-99</u>	<u>100+</u>
MC9183-6	6"	44.00	40.94	37.81	35.19
MC9183-12	12"	44.69	41.56	38.44	35.75
MC9183-18	18"	45.38	42.19	39.00	36.31
MC9183-24	24"	46.06	42.81	39.63	36.88
MC9183-36	36"	47.44	44.13	40.81	37.94
MC9183-48	48"	48.81	45.38	42.00	39.06
MC9183-60	60"	50.19	46.69	43.19	40.13
MC9183-72	72"	51.56	47.94	44.38	41.25
MC9183-XX	ANY	PRICE UPON REQUEST			

RG316/U COAX

<u>MODEL#</u>	<u>LENGTH</u>	<u>1-24</u>	<u>25-49</u>	<u>50-99</u>	<u>100+</u>
MC9184-6	6"	35.20	32.75	30.25	28.15
MC9184-12	12"	35.60	33.10	30.60	28.50
MC9184-18	18"	36.00	33.50	30.95	28.80
MC9184-24	24"	36.40	33.85	31.30	29.10
MC9184-36	36"	37.20	34.60	32.00	29.75
MC9184-48	48"	38.00	35.35	32.70	30.40
MC9184-60	60"	38.80	36.10	33.35	31.05
MC9184-72	72"	39.60	36.85	34.05	31.70
MC9184-XX	ANY	PRICE UPON REQUEST			

RG316-DS COAX, DOUBLE SHIELDED

<u>MODEL#</u>	<u>LENGTH</u>	<u>1-24</u>	<u>25-49</u>	<u>50-99</u>	<u>100+</u>
MC9185-6	6"	37.40	34.80	32.15	29.90
MC9185-12	12"	38.40	35.70	33.00	30.70
MC9185-18	18"	39.40	36.65	33.90	31.50
MC9185-24	24"	40.40	37.55	34.75	32.30
MC9185-36	36"	42.40	39.45	36.45	33.90
MC9185-48	48"	44.40	41.30	38.20	35.50
MC9185-60	60"	46.40	43.15	39.90	37.10
MC9185-72	72"	48.40	45.00	41.60	38.70
MC9185-XX	ANY	PRICE UPON REQUEST			

RG400/U COAX, DOUBLE SHIELDED

<u>MODEL#</u>	<u>LENGTH</u>	<u>1-24</u>	<u>25-49</u>	<u>50-99</u>	<u>100+</u>
MC9186-6	6"	37.40	34.80	32.15	29.90
MC9186-12	12"	38.50	35.80	33.10	30.80
MC9186-18	18"	39.60	36.85	34.05	31.70
MC9186-24	24"	40.70	37.85	35.00	32.55
MC9186-36	36"	42.90	39.90	36.90	34.30
MC9186-48	48"	45.10	41.95	38.80	36.10
MC9186-60	60"	47.30	44.00	40.70	37.85
MC9186-72	72"	49.50	46.05	42.55	39.60
MC9186-XX	ANY	PRICE UPON REQUEST			

TIMES LMR-240

<u>MODEL#</u>	<u>LENGTH</u>	<u>1-24</u>	<u>25-49</u>	<u>50-99</u>	<u>100+</u>
MC9443-12	12"	26.35	25.03	23.78	22.59
MC9443-24	24"	27.00	25.65	24.37	23.15
MC9443-36	36"	27.65	26.27	24.95	23.71
MC9443-48	48"	28.30	26.89	25.54	24.26
MC9443-60	60"	28.95	27.50	26.13	24.82
MC9443-72	72"	29.60	28.12	26.71	25.38
MC9443-XX	ANY	PRICE UPON REQUEST			



RG58C/U COAX

<u>MODEL#</u>	<u>LENGTH</u>	<u>1-24</u>	<u>25-49</u>	<u>50-99</u>	<u>100+</u>
MC9188-6	6"	37.40	34.80	32.15	29.90
MC9188-12	12"	37.55	34.95	32.30	30.05
MC9188-18	18"	37.75	35.10	32.45	30.20
MC9188-24	24"	37.90	35.25	32.60	30.35
MC9188-36	36"	38.25	35.55	32.90	30.60
MC9188-48	48"	38.60	35.90	33.20	30.85
MC9188-60	60"	38.95	36.20	33.50	31.15
MC9188-72	72"	39.25	36.50	33.75	31.40
MC9188-XX	ANY	PRICE UPON REQUEST			

RG316/U COAX

<u>MODEL#</u>	<u>LENGTH</u>	<u>1-24</u>	<u>25-49</u>	<u>50-99</u>	<u>100+</u>
MC9194-6	6"	37.40	34.80	32.15	29.90
MC9194-12	12"	37.80	35.15	32.50	30.25
MC9194-18	18"	38.20	35.55	32.85	30.55
MC9194-24	24"	38.60	35.90	33.20	30.90
MC9194-36	36"	39.40	36.65	33.90	31.50
MC9194-48	48"	40.20	37.40	34.55	32.15
MC9194-60	60"	41.00	38.15	35.25	32.80
MC9194-72	72"	41.80	38.85	35.95	33.45
MC9194-XX	ANY	PRICE UPON REQUEST			

RG142B/U COAX, DOUBLE SHIELDED

<u>MODEL#</u>	<u>LENGTH</u>	<u>1-24</u>	<u>25-49</u>	<u>50-99</u>	<u>100+</u>
MC9189-6	6"	49.50	46.06	42.56	39.63
MC9189-12	12"	50.88	47.31	43.75	40.69
MC9189-18	18"	52.25	48.56	44.94	41.81
MC9189-24	24"	53.63	49.88	46.13	42.88
MC9189-36	36"	56.38	52.44	48.50	45.13
MC9189-48	48"	59.13	55.00	50.88	47.31
MC9189-60	60"	61.88	57.56	53.19	49.50
MC9189-72	72"	64.63	60.13	55.56	51.69
MC9189-XX	ANY	PRICE UPON REQUEST			

RG316-DS COAX, DOUBLE SHIELDED

<u>MODEL#</u>	<u>LENGTH</u>	<u>1-24</u>	<u>25-49</u>	<u>50-99</u>	<u>100+</u>
MC9195-6	6"	39.60	36.85	34.05	31.70
MC9195-12	12"	40.60	37.75	34.90	32.50
MC9195-18	18"	41.60	38.70	35.80	33.30
MC9195-24	24"	42.60	39.60	36.65	34.10
MC9195-36	36"	44.60	41.50	38.35	35.70
MC9195-48	48"	46.60	43.35	40.10	37.30
MC9195-60	60"	48.60	45.20	41.80	38.90
MC9195-72	72"	50.60	47.05	43.50	40.50
MC9195-XX	ANY	PRICE UPON REQUEST			

RG174A/U COAX

<u>MODEL#</u>	<u>LENGTH</u>	<u>1-24</u>	<u>25-49</u>	<u>50-99</u>	<u>100+</u>
MC9190-6	6"	37.40	34.80	32.15	29.90
MC9190-12	12"	37.50	34.90	32.25	30.00
MC9190-18	18"	37.60	35.00	32.35	30.10
MC9190-24	24"	37.75	35.10	32.45	30.20
MC9190-36	36"	37.95	35.30	32.65	30.35
MC9190-48	48"	38.15	35.50	32.85	30.55
MC9190-60	60"	38.40	35.70	33.00	30.70
MC9190-72	72"	38.60	35.90	33.20	30.90
MC9190-XX	ANY	PRICE UPON REQUEST			

RG400/U COAX, DOUBLE SHIELDED

<u>MODEL#</u>	<u>LENGTH</u>	<u>1-24</u>	<u>25-49</u>	<u>50-99</u>	<u>100+</u>
MC9196-6	6"	39.60	36.85	34.05	31.70
MC9196-12	12"	40.70	37.85	35.00	32.55
MC9196-18	18"	41.80	38.85	35.95	33.45
MC9196-24	24"	42.90	39.90	36.90	34.30
MC9196-36	36"	45.10	41.95	38.80	36.10
MC9196-48	48"	47.30	44.00	40.70	37.85
MC9196-60	60"	49.50	46.05	42.55	39.60
MC9196-72	72"	51.70	48.10	44.45	41.35
MC9196-XX	ANY	PRICE UPON REQUEST			

RG223/U COAX, DOUBLE SHIELDED

<u>MODEL#</u>	<u>LENGTH</u>	<u>1-24</u>	<u>25-49</u>	<u>50-99</u>	<u>100+</u>
MC9193-6	6"	46.75	43.50	40.19	37.38
MC9193-12	12"	47.44	44.13	40.81	37.94
MC9193-18	18"	48.13	44.75	41.38	38.50
MC9193-24	24"	48.81	45.38	42.00	39.06
MC9193-36	36"	50.19	46.69	43.19	40.13
MC9193-48	48"	51.56	47.94	44.38	41.23
MC9193-60	60"	52.94	49.25	45.50	42.38
MC9193-72	72"	54.31	50.50	46.69	43.44
MC9193-XX	ANY	PRICE UPON REQUEST			

TIMES LMR-240

<u>MODEL#</u>	<u>LENGTH</u>	<u>1-24</u>	<u>25-49</u>	<u>50-99</u>	<u>100+</u>
MC9442-12	12"	31.30	29.74	28.25	26.84
MC9442-24	24"	31.95	30.35	28.83	27.39
MC9442-36	36"	32.60	30.40	28.88	27.44
MC9442-48	48"	33.25	31.59	30.00	28.50
MC9442-60	60"	33.90	32.20	30.59	29.06
MC9442-72	72"	34.55	32.82	31.18	29.62
MC9442-XX	ANY	PRICE UPON REQUEST			



RG58C/U COAX

<u>MODEL#</u>	<u>LENGTH</u>	<u>1-24</u>	<u>25-49</u>	<u>50-99</u>	<u>100+</u>
MC9197-6	6"	37.40	34.80	32.15	29.90
MC9197-12	12"	37.55	34.95	32.30	30.05
MC9197-18	18"	37.75	35.10	32.45	30.20
MC9197-24	24"	37.90	35.25	32.60	30.35
MC9197-36	36"	38.25	35.55	32.90	30.60
MC9197-48	48"	38.60	35.90	33.20	30.85
MC9197-60	60"	38.95	36.20	33.50	31.15
MC9197-72	72"	39.25	36.50	33.75	31.40
MC9197-XX	ANY	PRICE UPON REQUEST			

RG316/U COAX

<u>MODEL#</u>	<u>LENGTH</u>	<u>1-24</u>	<u>25-49</u>	<u>50-99</u>	<u>100+</u>
MC9204-6	6"	37.40	34.80	32.15	29.90
MC9204-12	12"	37.80	35.15	32.50	30.25
MC9204-18	18"	38.20	35.55	32.85	30.55
MC9204-24	24"	38.60	35.90	33.20	30.90
MC9204-36	36"	39.40	36.65	33.90	31.50
MC9204-48	48"	40.20	37.40	34.55	32.15
MC9204-60	60"	41.00	38.15	35.25	32.80
MC9204-72	72"	41.80	38.85	35.95	33.45
MC9204-XX	ANY	PRICE UPON REQUEST			

RG142B/U COAX, DOUBLE SHIELDED

<u>MODEL#</u>	<u>LENGTH</u>	<u>1-24</u>	<u>25-49</u>	<u>50-99</u>	<u>100+</u>
MC9198-6	6"	49.50	46.06	42.56	39.63
MC9198-12	12"	50.88	47.31	43.75	40.69
MC9198-18	18"	52.25	48.56	44.94	41.81
MC9198-24	24"	53.63	49.88	46.13	42.88
MC9198-36	36"	56.38	52.44	48.50	45.13
MC9198-48	48"	59.13	55.00	50.88	47.31
MC9198-60	60"	61.88	57.56	53.19	49.50
MC9198-72	72"	64.63	60.13	55.56	51.69
MC9198-XX	ANY	PRICE UPON REQUEST			

RG316-DS COAX, DOUBLE SHIELDED

<u>MODEL#</u>	<u>LENGTH</u>	<u>1-24</u>	<u>25-49</u>	<u>50-99</u>	<u>100+</u>
MC9205-6	6"	39.60	36.85	34.05	31.70
MC9205-12	12"	40.60	37.75	34.90	32.50
MC9205-18	18"	41.60	38.70	35.80	33.30
MC9205-24	24"	42.60	39.60	36.65	34.10
MC9205-36	36"	44.60	41.50	38.35	35.70
MC9205-48	48"	46.60	43.35	40.10	37.30
MC9205-60	60"	48.60	45.20	41.80	38.90
MC9205-72	72"	50.60	47.05	43.50	40.50
MC9205-XX	ANY	PRICE UPON REQUEST			

RG174A/U COAX

<u>MODEL#</u>	<u>LENGTH</u>	<u>1-24</u>	<u>25-49</u>	<u>50-99</u>	<u>100+</u>
MC9199-6	6"	37.40	34.80	32.15	29.90
MC9199-12	12"	37.50	34.90	32.25	30.00
MC9199-18	18"	37.60	35.00	32.35	30.10
MC9199-24	24"	37.75	35.10	32.45	30.20
MC9199-36	36"	37.95	35.30	32.65	30.35
MC9199-48	48"	38.15	35.50	32.85	30.55
MC9199-60	60"	38.40	35.70	33.00	30.70
MC9199-72	72"	38.60	35.90	33.20	30.90
MC9199-XX	ANY	PRICE UPON REQUEST			

RG400/U COAX, DOUBLE SHIELDED

<u>MODEL#</u>	<u>LENGTH</u>	<u>1-24</u>	<u>25-49</u>	<u>50-99</u>	<u>100+</u>
MC9206-6	6"	39.60	36.85	34.05	31.70
MC9206-12	12"	40.70	37.85	35.00	32.55
MC9206-18	18"	41.80	38.85	35.95	33.45
MC9206-24	24"	42.90	39.90	36.90	34.30
MC9206-36	36"	45.10	41.95	38.80	36.10
MC9206-48	48"	47.30	44.00	40.70	37.85
MC9206-60	60"	49.50	46.05	42.55	39.60
MC9206-72	72"	51.70	48.10	44.45	41.35
MC9206-XX	ANY	PRICE UPON REQUEST			

RG223/U COAX, DOUBLE SHIELDED

<u>MODEL#</u>	<u>LENGTH</u>	<u>1-24</u>	<u>25-49</u>	<u>50-99</u>	<u>100+</u>
MC9203-6	6"	46.75	43.50	40.19	37.38
MC9203-12	12"	47.44	44.13	40.81	37.94
MC9203-18	18"	48.13	44.75	41.38	38.50
MC9203-24	24"	48.81	45.38	42.00	39.06
MC9203-36	36"	50.19	46.69	43.19	40.13
MC9203-48	48"	51.56	47.94	44.38	41.23
MC9203-60	60"	52.94	49.25	45.50	42.38
MC9203-72	72"	54.31	50.50	46.69	43.44
MC9203-XX	ANY	PRICE UPON REQUEST			

TIMES LMR-240

<u>MODEL#</u>	<u>LENGTH</u>	<u>1-24</u>	<u>25-49</u>	<u>50-99</u>	<u>100+</u>
MC9441-12	12"	34.90	33.16	31.50	29.92
MC9441-24	24"	35.55	33.77	32.08	30.47
MC9441-36	36"	36.20	34.39	32.67	31.04
MC9441-48	48"	36.85	35.00	33.26	31.59
MC9441-60	60"	37.50	35.63	33.84	32.15
MC9441-72	72"	38.15	36.24	34.43	32.71
MC9441-XX	ANY	PRICE UPON REQUEST			

SMA MALE TO N FEMALE BULKHEAD



RG58C/U COAX

<u>MODEL#</u>	<u>LENGTH</u>	<u>1-24</u>	<u>25-49</u>	<u>50-99</u>	<u>100+</u>
MC9208-6	6"	37.40	34.80	32.15	29.90
MC9208-12	12"	37.55	34.95	32.30	30.05
MC9208-18	18"	37.75	35.10	32.45	30.20
MC9208-24	24"	37.90	35.25	32.60	30.35
MC9208-36	36"	38.25	35.55	32.90	30.60
MC9208-48	48"	38.60	35.90	33.20	30.85
MC9208-60	60"	38.95	36.20	33.50	31.15
MC9208-72	72"	39.25	36.50	33.75	31.40
MC9208-XX	ANY	PRICE UPON REQUEST			

RG316/U COAX

<u>MODEL#</u>	<u>LENGTH</u>	<u>1-24</u>	<u>25-49</u>	<u>50-99</u>	<u>100+</u>
MC9212-6	6"	37.40	34.80	32.15	29.90
MC9212-12	12"	37.80	35.15	32.50	30.25
MC9212-18	18"	38.20	35.55	32.85	30.55
MC9212-24	24"	38.60	35.90	33.20	30.90
MC9212-36	36"	39.40	36.65	33.90	31.50
MC9212-48	48"	40.20	37.40	34.55	32.15
MC9212-60	60"	41.00	38.15	35.25	32.80
MC9212-72	72"	41.80	38.85	35.95	33.45
MC9212-XX	ANY	PRICE UPON REQUEST			

RG142B/U COAX, DOUBLE SHIELDED

<u>MODEL#</u>	<u>LENGTH</u>	<u>1-24</u>	<u>25-49</u>	<u>50-99</u>	<u>100+</u>
MC9209-6	6"	49.50	46.06	42.56	39.63
MC9209-12	12"	50.88	47.31	43.75	40.69
MC9209-18	18"	52.25	48.56	44.94	41.81
MC9209-24	24"	53.63	49.88	46.13	42.88
MC9209-36	36"	56.38	52.44	48.50	45.13
MC9209-48	48"	59.13	55.00	50.88	47.31
MC9209-60	60"	61.88	57.56	53.19	49.50
MC9209-72	72"	64.63	60.13	55.56	51.69
MC9209-XX	ANY	PRICE UPON REQUEST			

RG316-DS COAX, DOUBLE SHIELDED

<u>MODEL#</u>	<u>LENGTH</u>	<u>1-24</u>	<u>25-49</u>	<u>50-99</u>	<u>100+</u>
MC9213-6	6"	39.60	36.85	34.05	31.70
MC9213-12	12"	40.60	37.75	34.90	32.50
MC9213-18	18"	41.60	38.70	35.80	33.30
MC9213-24	24"	42.60	39.60	36.65	34.10
MC9213-36	36"	44.60	41.50	38.35	35.70
MC9213-48	48"	46.60	43.35	40.10	37.30
MC9213-60	60"	48.60	45.20	41.80	38.90
MC9213-72	72"	50.60	47.05	43.50	40.50
MC9213-XX	ANY	PRICE UPON REQUEST			

RG174A/U COAX

<u>MODEL#</u>	<u>LENGTH</u>	<u>1-24</u>	<u>25-49</u>	<u>50-99</u>	<u>100+</u>
MC9210-6	6"	37.40	34.80	32.15	29.90
MC9210-12	12"	37.50	34.90	32.25	30.00
MC9210-18	18"	37.60	35.00	32.35	30.10
MC9210-24	24"	37.75	35.10	32.45	30.20
MC9210-36	36"	37.95	35.30	32.65	30.35
MC9210-48	48"	38.15	35.50	32.85	30.55
MC9210-60	60"	38.40	35.70	33.00	30.70
MC9210-72	72"	38.60	35.90	33.20	30.90
MC9210-XX	ANY	PRICE UPON REQUEST			

RG400/U COAX, DOUBLE SHIELDED

<u>MODEL#</u>	<u>LENGTH</u>	<u>1-24</u>	<u>25-49</u>	<u>50-99</u>	<u>100+</u>
MC9214-6	6"	39.60	36.85	34.05	31.70
MC9214-12	12"	40.70	37.85	35.00	32.55
MC9214-18	18"	41.80	38.85	35.95	33.45
MC9214-24	24"	42.90	39.90	36.90	34.30
MC9214-36	36"	45.10	41.95	38.80	36.10
MC9214-48	48"	47.30	44.00	40.70	37.85
MC9214-60	60"	49.50	46.05	42.55	39.60
MC9214-72	72"	51.70	48.10	44.45	41.35
MC9214-XX	ANY	PRICE UPON REQUEST			

RG223/U COAX, DOUBLE SHIELDED

<u>MODEL#</u>	<u>LENGTH</u>	<u>1-24</u>	<u>25-49</u>	<u>50-99</u>	<u>100+</u>
MC9211-6	6"	46.75	43.50	40.19	37.38
MC9211-12	12"	47.44	44.13	40.81	37.94
MC9211-18	18"	48.13	44.75	41.38	38.50
MC9211-24	24"	48.81	45.38	42.00	39.06
MC9211-36	36"	50.19	46.69	43.19	40.13
MC9211-48	48"	51.56	47.94	44.38	41.23
MC9211-60	60"	52.94	49.25	45.50	42.38
MC9211-72	72"	54.31	50.50	46.69	43.44
MC9211-XX	ANY	PRICE UPON REQUEST			

TIMES LMR-240

<u>MODEL#</u>	<u>LENGTH</u>	<u>1-24</u>	<u>25-49</u>	<u>50-99</u>	<u>100+</u>
MC9440-12	12"	30.77	29.23	27.77	26.38
MC9440-24	24"	31.42	29.85	28.36	26.94
MC9440-36	36"	32.07	30.47	28.94	27.49
MC9440-48	48"	32.72	31.08	29.53	28.05
MC9440-60	60"	33.37	31.70	30.12	28.61
MC9440-72	72"	34.02	32.32	30.70	29.17
MC9440-XX	ANY	PRICE UPON REQUEST			

SMA MALE TO N MALE



RG58C/U COAX

<u>MODEL#</u>	<u>LENGTH</u>	<u>1-24</u>	<u>25-49</u>	<u>50-99</u>	<u>100+</u>
MC9216-12	12"	26.40	24.55	22.70	21.10
MC9216-24	24"	26.75	24.85	23.00	21.40
MC9216-36	36"	27.10	25.20	23.30	21.65
MC9216-48	48"	27.40	25.50	23.60	21.95
MC9216-60	60"	27.75	25.80	23.85	22.20
MC9216-72	72"	28.10	26.15	24.15	22.50
MC9216-XX	ANY	PRICE UPON REQUEST			

RG316/U COAX

<u>MODEL#</u>	<u>LENGTH</u>	<u>1-24</u>	<u>25-49</u>	<u>50-99</u>	<u>100+</u>
MC9220-12	12"	29.70	27.60	25.55	23.75
MC9220-24	24"	30.50	28.35	26.25	24.40
MC9220-36	36"	31.30	29.10	26.90	25.05
MC9220-48	48"	32.10	29.85	27.60	25.70
MC9220-60	60"	32.90	30.60	28.30	26.30
MC9220-72	72"	33.70	31.35	29.00	26.95
MC9220-XX	ANY	PRICE UPON REQUEST			

RG142B/U COAX, DOUBLE SHIELDED

<u>MODEL#</u>	<u>LENGTH</u>	<u>1-24</u>	<u>25-49</u>	<u>50-99</u>	<u>100+</u>
MC9217-12	12"	33.00	30.69	28.38	26.38
MC9217-24	24"	35.75	33.25	30.75	28.63
MC9217-36	36"	38.50	35.81	33.13	30.81
MC9217-48	48"	41.25	38.38	35.50	33.00
MC9217-60	60"	44.00	40.94	37.81	35.19
MC9217-72	72"	46.75	43.50	40.19	37.38
MC9217-XX	ANY	PRICE UPON REQUEST			

RG316-DS COAX, DOUBLE SHIELDED

<u>MODEL#</u>	<u>LENGTH</u>	<u>1-24</u>	<u>25-49</u>	<u>50-99</u>	<u>100+</u>
MC9221-12	12"	34.10	31.70	29.35	27.30
MC9221-24	24"	36.10	33.55	31.05	28.90
MC9221-36	36"	38.10	35.45	32.75	30.50
MC9221-48	48"	40.10	37.30	34.50	32.10
MC9221-60	60"	42.10	39.15	36.20	33.70
MC9221-72	72"	44.10	41.00	37.95	35.30
MC9221-XX	ANY	PRICE UPON REQUEST			

RG174A/U COAX

<u>MODEL#</u>	<u>LENGTH</u>	<u>1-24</u>	<u>25-49</u>	<u>50-99</u>	<u>100+</u>
MC9218-12	12"	29.70	27.60	25.55	23.75
MC9218-24	24"	29.90	27.85	25.75	23.95
MC9218-36	36"	30.15	28.05	25.90	24.10
MC9218-48	48"	30.35	28.25	26.10	24.30
MC9218-60	60"	30.60	28.45	26.30	24.45
MC9218-72	72"	30.80	28.65	26.50	24.65
MC9218-XX	ANY	PRICE UPON REQUEST			

RG400/U COAX, DOUBLE SHIELDED

<u>MODEL#</u>	<u>LENGTH</u>	<u>1-24</u>	<u>25-49</u>	<u>50-99</u>	<u>100+</u>
MC9222-12	12"	26.40	24.55	22.70	21.10
MC9222-24	24"	28.60	26.60	24.60	22.90
MC9222-36	36"	30.80	28.65	26.50	24.65
MC9222-48	48"	33.00	30.70	28.40	26.40
MC9222-60	60"	35.20	32.75	30.25	28.15
MC9222-72	72"	37.40	34.80	32.15	29.90
MC9222-XX	ANY	PRICE UPON REQUEST			

RG223/U COAX, DOUBLE SHIELDED

<u>MODEL#</u>	<u>LENGTH</u>	<u>1-24</u>	<u>25-49</u>	<u>50-99</u>	<u>100+</u>
MC9219-12	12"	33.00	30.69	28.38	26.38
MC9219-24	24"	34.38	32.00	29.56	27.50
MC9219-36	36"	35.75	33.25	30.75	28.63
MC9219-48	48"	37.13	34.50	31.94	29.69
MC9219-60	60"	38.50	35.81	33.13	30.81
MC9219-72	72"	39.88	37.06	34.31	31.88
MC9219-XX	ANY	PRICE UPON REQUEST			

TIMES LMR-240

<u>MODEL#</u>	<u>LENGTH</u>	<u>1-24</u>	<u>25-49</u>	<u>50-99</u>	<u>100+</u>
MC9439-12	12"	27.55	26.20	24.90	23.65
MC9439-24	24"	28.35	26.95	25.60	24.35
MC9439-36	36"	29.15	27.70	26.35	25.05
MC9439-48	48"	29.95	28.50	27.10	25.75
MC9439-60	60"	30.75	29.25	27.80	26.40
MC9439-72	72"	31.55	30.00	28.50	27.10
MC9439-XX	ANY	PRICE UPON REQUEST			



RG58C/U COAX

<u>MODEL#</u>	<u>LENGTH</u>	<u>1-24</u>	<u>25-49</u>	<u>50-99</u>	<u>100+</u>
MC9224-12	12"	19.80	18.40	17.05	15.85
MC9224-24	24"	20.15	18.75	17.30	16.10
MC9224-36	36"	20.50	19.05	17.60	16.40
MC9224-48	48"	20.80	19.35	17.90	16.65
MC9224-60	60"	21.15	19.70	18.20	16.95
MC9224-72	72"	21.50	20.00	18.50	17.20
MC9224-XX	ANY	PRICE UPON REQUEST			

RG142B/U COAX, DOUBLE SHIELDED

<u>MODEL#</u>	<u>LENGTH</u>	<u>1-24</u>	<u>25-49</u>	<u>50-99</u>	<u>100+</u>
MC9225-6	6"	31.63	29.38	27.19	25.31
MC9225-12	12"	33.00	30.69	28.38	26.38
MC9225-18	18"	34.38	32.00	29.56	27.50
MC9225-24	24"	35.75	33.25	30.75	28.63
MC9225-30	30"	37.13	34.50	31.94	29.69
MC9225-36	36"	38.50	35.81	33.13	30.81
MC9225-48	48"	41.25	38.38	35.50	33.00
MC9225-60	60"	44.00	40.94	37.81	35.19
MC9225-72	72"	46.75	43.50	40.19	37.38
MC9225-XX	ANY	PRICE UPON REQUEST			

RG213/U COAX

<u>MODEL#</u>	<u>LENGTH</u>	<u>1-24</u>	<u>25-49</u>	<u>50-99</u>	<u>100+</u>
MC9226-12	12"	33.65	31.29	28.94	26.94
MC9226-24	24"	34.65	32.24	29.76	27.71
MC9226-36	36"	35.65	33.12	30.65	28.47
MC9226-48	48"	36.59	34.06	31.47	29.29
MC9226-60	60"	37.59	34.94	32.35	30.06
MC9226-72	72"	38.59	35.88	33.18	30.87
MC9226-XX	ANY	PRICE UPON REQUEST			

RG214/U COAX, DOUBLE SHIELDED

<u>MODEL#</u>	<u>LENGTH</u>	<u>1-24</u>	<u>25-49</u>	<u>50-99</u>	<u>100+</u>
MC9227-12	12"	37.53	34.88	32.29	30.00
MC9227-24	24"	41.06	38.18	35.29	32.82
MC9227-36	36"	44.59	41.47	38.35	35.65
MC9227-48	48"	48.12	44.76	41.35	38.47
MC9227-60	60"	51.65	48.06	44.41	41.29
MC9227-72	72"	55.18	51.29	47.47	44.12
MC9227-84	84"	58.71	54.59	50.47	46.94
MC9227-96	96"	62.24	57.88	53.53	49.76
MC9227-108	108"	65.76	61.18	56.53	52.59
MC9227-120	120"	69.29	64.47	59.59	55.41
MC9227-144	144"	76.35	71.00	65.65	61.06
MC9227-XX	ANY	PRICE UPON REQUEST			

TIMES LMR-400

<u>MODEL#</u>	<u>LENGTH</u>	<u>1-24</u>	<u>25-49</u>	<u>50-99</u>	<u>100+</u>
MC9438-12	12"	24.50	23.30	22.15	21.05
MC9438-24	24"	25.60	24.35	23.15	22.00
MC9438-36	36"	26.70	25.40	24.15	23.00
MC9438-48	48"	27.80	26.40	25.10	23.85
MC9438-60	60"	28.90	27.50	26.15	24.85
MC9438-72	72"	30.00	28.50	27.10	25.75
MC9438-XX	ANY	PRICE UPON REQUEST			

RG217/U COAX, DOUBLE SHIELDED

<u>MODEL#</u>	<u>LENGTH</u>	<u>1-24</u>	<u>25-49</u>	<u>50-99</u>	<u>100+</u>
MC9228-12	12"	61.60	57.30	53.00	49.30
MC9228-24	24"	63.60	59.15	54.70	50.90
MC9228-36	36"	65.60	61.00	56.40	52.50
MC9228-48	48"	67.60	62.85	58.15	54.10
MC9228-60	60"	69.60	64.75	59.85	55.70
MC9228-72	72"	71.60	66.60	61.60	57.30
MC9228-84	84"	73.60	68.45	63.30	58.90
MC9228-96	96"	75.60	70.30	65.00	60.50
MC9228-108	108"	77.60	72.15	66.75	62.10
MC9228-120	120"	79.60	74.05	68.45	63.70
MC9228-144	144"	83.60	77.75	71.90	66.90
MC9228-XX	ANY	PRICE UPON REQUEST			

RG223/U COAX, DOUBLE SHIELDED

<u>MODEL#</u>	<u>LENGTH</u>	<u>1-24</u>	<u>25-49</u>	<u>50-99</u>	<u>100+</u>
MC9229-6	6"	31.63	29.38	27.19	25.31
MC9229-12	12"	32.31	30.06	27.81	25.88
MC9229-18	18"	33.00	30.69	28.38	26.38
MC9229-24	24"	33.69	31.31	29.00	26.94
MC9229-30	30"	34.38	32.00	29.56	27.50
MC9229-36	36"	35.06	32.63	30.13	28.06
MC9229-48	48"	36.44	33.88	31.31	29.13
MC9229-60	60"	37.81	35.19	32.50	30.25
MC9229-72	72"	39.19	36.44	33.69	31.38
MC9229-XX	ANY	PRICE UPON REQUEST			

RG316/U COAX

<u>MODEL#</u>	<u>LENGTH</u>	<u>1-24</u>	<u>25-49</u>	<u>50-99</u>	<u>100+</u>
MC9230-12	12"	29.70	27.60	25.55	23.75
MC9230-24	24"	30.50	28.35	26.25	24.40
MC9230-36	36"	31.30	29.10	26.90	25.05
MC9230-48	48"	32.10	29.85	27.60	25.70
MC9230-60	60"	32.90	30.60	28.30	26.30
MC9230-72	72"	33.70	31.35	29.00	26.95
MC9230-XX	ANY	PRICE UPON REQUEST			

RG393/U COAX, DOUBLE SHIELDED

<u>MODEL#</u>	<u>LENGTH</u>	<u>1-24</u>	<u>25-49</u>	<u>50-99</u>	<u>100+</u>
MC9231-12	12"	38.82	36.12	33.41	31.06
MC9231-24	24"	47.06	43.76	40.47	37.65
MC9231-36	36"	55.29	51.41	47.53	44.24
MC9231-48	48"	63.53	59.06	54.65	50.82
MC9231-60	60"	71.76	66.76	61.71	57.41
MC9231-72	72"	80.00	74.41	68.82	64.00
MC9231-XX	ANY	PRICE UPON REQUEST			

RG400/U COAX, DOUBLE SHIELDED

<u>MODEL#</u>	<u>LENGTH</u>	<u>1-24</u>	<u>25-49</u>	<u>50-99</u>	<u>100+</u>
MC9232-12	12"	25.30	23.55	21.75	20.25
MC9232-24	24"	27.50	25.60	23.65	22.00
MC9232-36	36"	29.70	27.60	25.55	23.75
MC9232-48	48"	31.90	29.65	27.45	25.50
MC9232-60	60"	34.10	31.70	29.35	27.30
MC9232-72	72"	36.30	33.75	31.20	29.05
MC9232-XX	ANY	PRICE UPON REQUEST			

N MALE TO N MALE RIGHT-ANGLE



RG58C/U COAX

<u>MODEL#</u>	<u>LENGTH</u>	<u>1-24</u>	<u>25-49</u>	<u>50-99</u>	<u>100+</u>
MC9233-12	12"	38.50	35.80	33.10	30.80
MC9233-24	24"	38.85	36.10	33.40	31.05
MC9233-36	36"	39.20	36.45	33.70	31.35
MC9233-48	48"	39.50	36.75	34.00	31.60
MC9233-60	60"	39.85	37.05	34.30	31.90
MC9233-72	72"	40.20	37.40	34.55	32.15
MC9233-XX	ANY	PRICE UPON REQUEST			

RG223/U COAX, DOUBLE SHIELDED

<u>MODEL#</u>	<u>LENGTH</u>	<u>1-24</u>	<u>25-49</u>	<u>50-99</u>	<u>100+</u>
MC9237-12	12"	48.13	44.75	41.38	38.50
MC9237-24	24"	49.50	46.06	42.56	39.63
MC9237-36	36"	50.88	47.31	43.75	40.69
MC9237-48	48"	52.25	48.56	44.94	41.81
MC9237-60	60"	53.63	49.88	46.13	42.88
MC9237-72	72"	55.00	51.13	47.31	44.00
MC9237-XX	ANY	PRICE UPON REQUEST			

RG142B/U COAX, DOUBLE SHIELDED

<u>MODEL#</u>	<u>LENGTH</u>	<u>1-24</u>	<u>25-49</u>	<u>50-99</u>	<u>100+</u>
MC9234-12	12"	48.13	44.75	41.38	38.50
MC9234-24	24"	50.88	47.31	43.75	40.68
MC9234-36	36"	53.63	49.88	46.13	54.13
MC9234-48	48"	56.38	52.44	48.50	45.13
MC9234-60	60"	59.13	55.00	50.88	47.31
MC9234-72	72"	61.88	57.56	53.19	49.50
MC9234-XX	ANY	PRICE UPON REQUEST			

RG393/U COAX, DOUBLE SHIELDED

<u>MODEL#</u>	<u>LENGTH</u>	<u>1-24</u>	<u>25-49</u>	<u>50-99</u>	<u>100+</u>
MC9239-12	12"	55.65	51.76	47.88	44.53
MC9239-24	24"	63.88	59.41	54.94	51.12
MC9239-36	36"	72.12	67.06	62.00	57.71
MC9239-48	48"	80.35	74.71	69.12	64.29
MC9239-60	60"	88.59	82.41	76.18	70.88
MC9239-72	72"	96.82	90.06	83.29	77.47
MC9239-XX	ANY	PRICE UPON REQUEST			

RG213/U COAX

<u>MODEL#</u>	<u>LENGTH</u>	<u>1-24</u>	<u>25-49</u>	<u>50-99</u>	<u>100+</u>
MC9235-12	12"	55.65	51.76	47.88	44.53
MC9235-24	24"	56.65	52.65	48.71	45.29
MC9235-36	36"	57.65	53.59	49.53	46.12
MC9235-48	48"	58.59	54.53	50.41	35.12
MC9235-60	60"	59.59	55.41	51.24	47.71
MC9235-72	72"	60.59	56.35	52.12	48.47
MC9235-XX	ANY	PRICE UPON REQUEST			

RG400/U COAX, DOUBLE SHIELDED

<u>MODEL#</u>	<u>LENGTH</u>	<u>1-24</u>	<u>25-49</u>	<u>50-99</u>	<u>100+</u>
MC9240-12	12"	38.50	35.80	33.10	30.80
MC9240-24	24"	40.70	37.85	35.00	32.55
MC9240-36	36"	42.90	39.90	36.90	34.30
MC9240-48	48"	45.10	41.95	38.80	36.10
MC9240-60	60"	47.30	44.00	40.70	37.85
MC9240-72	72"	49.50	46.05	42.55	39.60
MC9240-XX	ANY	PRICE UPON REQUEST			

RG214/U COAX, DOUBLE SHIELDED

<u>MODEL#</u>	<u>LENGTH</u>	<u>1-24</u>	<u>25-49</u>	<u>50-99</u>	<u>100+</u>
MC9236-12	12"	55.65	51.76	47.88	44.53
MC9236-24	24"	59.18	55.06	50.88	47.35
MC9236-36	36"	62.71	58.29	53.94	50.18
MC9236-48	48"	66.24	61.59	56.94	53.00
MC9236-60	60"	69.76	64.88	60.00	55.82
MC9236-72	72"	73.29	68.18	63.06	58.65
MC9236-XX	ANY	PRICE UPON REQUEST			

TIMES LMR-400

<u>MODEL#</u>	<u>LENGTH</u>	<u>1-24</u>	<u>25-49</u>	<u>50-99</u>	<u>100+</u>
MC9437-12	12"	33.85	32.20	30.60	29.10
MC9437-24	24"	34.95	33.20	31.55	30.00
MC9437-36	36"	36.05	34.25	32.55	30.95
MC9437-48	48"	37.15	35.30	33.55	31.90
MC9437-60	60"	38.25	36.35	34.55	32.85
MC9437-72	72"	39.35	37.40	35.55	33.80
MC9437-XX	ANY	PRICE UPON REQUEST			

N MALE TO N FEMALE



RG58C/U COAX

<u>MODEL#</u>	<u>LENGTH</u>	<u>1-24</u>	<u>25-49</u>	<u>50-99</u>	<u>100+</u>
MC9241-12	12"	24.20	22.50	20.80	19.35
MC9241-24	24"	24.55	22.80	21.10	19.65
MC9241-36	36"	24.90	23.15	21.40	19.90
MC9241-48	48"	25.20	23.45	21.70	20.20
MC9241-60	60"	25.55	23.75	22.00	20.45
MC9241-72	72"	25.90	24.10	22.25	20.70
MC9241-XX	ANY	PRICE UPON REQUEST			

RG214/U COAX, DOUBLE SHIELDED

<u>MODEL#</u>	<u>LENGTH</u>	<u>1-24</u>	<u>25-49</u>	<u>50-99</u>	<u>100+</u>
MC9244-12	12"	42.71	39.71	36.71	34.18
MC9244-24	24"	46.24	43.00	39.76	37.00
MC9244-36	36"	49.76	46.29	42.82	39.82
MC9244-48	48"	53.29	49.59	45.82	42.65
MC9244-60	60"	56.82	52.82	48.88	45.47
MC9244-72	72"	60.35	56.12	51.88	48.29
MC9244-XX	ANY	PRICE UPON REQUEST			

RG142B/U COAX, DOUBLE SHIELDED

<u>MODEL#</u>	<u>LENGTH</u>	<u>1-24</u>	<u>25-49</u>	<u>50-99</u>	<u>100+</u>
MC9242-12	12"	30.25	28.13	26.00	24.19
MC9242-24	24"	33.00	30.69	28.38	26.38
MC9242-36	36"	35.75	33.25	30.75	28.63
MC9242-48	48"	38.50	35.81	33.13	30.81
MC9242-60	60"	41.25	38.38	35.50	33.00
MC9242-72	72"	44.00	40.94	37.81	35.19
MC9242-XX	ANY	PRICE UPON REQUEST			

RG223/U COAX, DOUBLE SHIELDED

<u>MODEL#</u>	<u>LENGTH</u>	<u>1-24</u>	<u>25-49</u>	<u>50-99</u>	<u>100+</u>
MC9246-12	12"	30.25	28.13	26.00	24.19
MC9246-24	24"	31.63	29.44	27.19	25.31
MC9246-36	36"	33.00	30.69	28.38	26.38
MC9246-48	48"	34.38	32.00	29.56	27.50
MC9246-60	60"	35.75	33.25	30.75	28.63
MC9246-72	72"	37.13	34.50	31.94	29.69
MC9246-XX	ANY	PRICE UPON REQUEST			

RG213/U COAX

<u>MODEL#</u>	<u>LENGTH</u>	<u>1-24</u>	<u>25-49</u>	<u>50-99</u>	<u>100+</u>
MC9243-12	12"	40.12	43.65	34.53	32.12
MC9243-24	24"	41.12	38.24	35.35	32.88
MC9243-36	36"	42.12	39.18	36.18	33.65
MC9243-48	48"	43.06	40.06	37.06	34.47
MC9243-60	60"	44.06	41.00	37.88	35.24
MC9243-72	72"	45.06	41.88	38.76	36.06
MC9243-XX	ANY	PRICE UPON REQUEST			

RG400/U COAX, DOUBLE SHIELDED

<u>MODEL#</u>	<u>LENGTH</u>	<u>1-24</u>	<u>25-49</u>	<u>50-99</u>	<u>100+</u>
MC9251-12	12"	24.20	22.50	20.80	19.35
MC9251-24	24"	26.40	24.55	22.70	21.10
MC9251-36	36"	28.60	26.60	24.60	22.90
MC9251-48	48"	30.80	28.65	26.50	24.65
MC9251-60	60"	33.00	30.70	28.40	26.40
MC9251-72	72"	35.20	32.75	30.25	28.15
MC9251-XX	ANY	PRICE UPON REQUEST			

TIMES LMR-240

<u>MODEL#</u>	<u>LENGTH</u>	<u>1-24</u>	<u>25-49</u>	<u>50-99</u>	<u>100+</u>
MC9436-12	12"	24.35	23.15	22.00	20.90
MC9436-24	24"	25.25	24.00	22.80	21.70
MC9436-36	36"	26.15	24.85	23.60	22.45
MC9436-48	48"	27.05	26.00	24.70	23.50
MC9436-60	60"	27.95	26.55	25.25	24.00
MC9436-72	72"	28.85	27.40	26.05	24.75
MC9436-XX	ANY	PRICE UPON REQUEST			

TIMES LMR-400

<u>MODEL#</u>	<u>LENGTH</u>	<u>1-24</u>	<u>25-49</u>	<u>50-99</u>	<u>100+</u>
MC9435-12	12"	25.10	23.85	22.65	21.55
MC9435-24	24"	26.30	25.00	23.75	22.60
MC9435-36	36"	27.50	26.15	24.85	23.65
MC9435-48	48"	28.70	27.30	25.95	24.65
MC9435-60	60"	29.90	28.40	27.00	25.65
MC9435-72	72"	31.10	29.55	28.10	26.70
MC9435-XX	ANY	PRICE UPON REQUEST			

N MALE TO N FEMALE BULKHEAD



RG58C/U COAX

<u>MODEL#</u>	<u>LENGTH</u>	<u>1-24</u>	<u>25-49</u>	<u>50-99</u>	<u>100+</u>
MC9252-12	12"	37.40	34.80	32.15	29.90
MC9252-24	24"	37.75	35.10	32.45	30.20
MC9252-36	36"	38.10	35.40	32.75	30.45
MC9252-48	48"	38.40	35.75	33.05	30.75
MC9252-60	60"	38.75	36.05	33.35	31.00
MC9252-72	72"	39.10	36.35	33.65	31.30
MC9252-XX	ANY	PRICE UPON REQUEST			

RG142B/U COAX, DOUBLE SHIELDED

<u>MODEL#</u>	<u>LENGTH</u>	<u>1-24</u>	<u>25-49</u>	<u>50-99</u>	<u>100+</u>
MC9253-12	12"	46.75	43.50	40.19	37.38
MC9253-24	24"	49.50	46.06	42.56	39.63
MC9253-36	36"	52.25	48.56	44.94	41.81
MC9253-48	48"	55.00	51.13	47.31	44.00
MC9253-60	60"	57.75	53.69	49.69	46.19
MC9253-72	72"	60.50	56.26	52.00	48.38
MC9253-XX	ANY	PRICE UPON REQUEST			

RG213/U COAX

<u>MODEL#</u>	<u>LENGTH</u>	<u>1-24</u>	<u>25-49</u>	<u>50-99</u>	<u>100+</u>
MC9254-12	12"	53.06	49.35	45.65	42.47
MC9254-24	24"	54.06	50.24	46.47	43.24
MC9254-36	36"	55.06	51.18	47.35	44.00
MC9254-48	48"	56.00	52.18	48.18	44.82
MC9254-60	60"	57.00	53.00	49.06	45.59
MC9254-72	72"	58.00	53.94	49.88	46.41
MC9254-XX	ANY	PRICE UPON REQUEST			

RG214/U COAX, DOUBLE SHIELDED

<u>MODEL#</u>	<u>LENGTH</u>	<u>1-24</u>	<u>25-49</u>	<u>50-99</u>	<u>100+</u>
MC9255-12	12"	53.06	49.35	45.65	42.47
MC9255-24	24"	56.59	52.65	48.65	45.29
MC9255-36	36"	60.12	55.91	51.71	48.12
MC9255-48	48"	63.65	59.18	54.76	50.94
MC9255-60	60"	67.18	62.47	57.76	53.76
MC9255-72	72"	70.71	65.76	60.82	56.59
MC9255-XX	ANY	PRICE UPON REQUEST			

RG223/U COAX, DOUBLE SHIELDED

<u>MODEL#</u>	<u>LENGTH</u>	<u>1-24</u>	<u>25-49</u>	<u>50-99</u>	<u>100+</u>
MC9256-12	12"	46.75	43.50	40.19	37.38
MC9256-24	24"	48.13	44.75	41.38	38.50
MC9256-36	36"	49.50	46.06	42.56	39.63
MC9256-48	48"	50.88	47.31	43.75	40.69
MC9256-60	60"	52.25	48.56	44.94	41.81
MC9256-72	72"	53.63	49.88	46.13	42.88
MC9256-XX	ANY	PRICE UPON REQUEST			

RG316/U COAX

<u>MODEL#</u>	<u>LENGTH</u>	<u>1-24</u>	<u>25-49</u>	<u>50-99</u>	<u>100+</u>
MC9258-12	12"	45.10	41.95	38.80	36.10
MC9258-24	24"	45.90	42.70	39.45	36.70
MC9258-36	36"	46.70	43.45	40.15	37.35
MC9258-48	48"	47.50	44.20	40.85	38.00
MC9258-60	60"	48.30	44.90	41.55	38.65
MC9258-72	72"	49.10	45.65	42.25	39.30
MC9258-XX	ANY	PRICE UPON REQUEST			

RG316-DS COAX, DOUBLE SHIELDED

<u>MODEL#</u>	<u>LENGTH</u>	<u>1-24</u>	<u>25-49</u>	<u>50-99</u>	<u>100+</u>
MC9259-12	12"	45.10	41.95	38.80	36.10
MC9259-24	24"	47.10	43.80	40.50	37.70
MC9259-36	36"	49.10	45.65	42.25	39.30
MC9259-48	48"	51.10	47.50	43.95	40.90
MC9259-60	60"	53.10	49.40	45.65	42.50
MC9259-72	72"	55.10	51.25	49.40	44.10
MC9259-XX	ANY	PRICE UPON REQUEST			

RG393/U COAX, DOUBLE SHIELDED

<u>MODEL#</u>	<u>LENGTH</u>	<u>1-24</u>	<u>25-49</u>	<u>50-99</u>	<u>100+</u>
MC9260-12	12"	53.06	49.35	45.65	42.47
MC9260-24	24"	61.29	57.00	52.71	49.06
MC9260-36	36"	69.53	64.65	59.82	55.65
MC9260-48	48"	77.76	72.29	66.88	62.24
MC9260-60	60"	86.00	80.00	73.94	68.82
MC9260-72	72"	94.24	87.65	81.06	75.41
MC9260-XX	ANY	PRICE UPON REQUEST			

RG400/U COAX, DOUBLE SHIELDED

<u>MODEL#</u>	<u>LENGTH</u>	<u>1-24</u>	<u>25-49</u>	<u>50-99</u>	<u>100+</u>
MC9261-12	12"	37.40	34.80	32.15	29.90
MC9261-24	24"	39.60	36.85	34.05	31.70
MC9261-36	36"	41.80	38.85	35.95	33.45
MC9261-48	48"	44.00	40.90	37.85	35.20
MC9261-60	60"	46.20	42.95	39.75	36.95
MC9261-72	72"	48.40	45.00	41.60	38.70
MC9261-XX	ANY	PRICE UPON REQUEST			

TIMES LMR-400

<u>MODEL#</u>	<u>LENGTH</u>	<u>1-24</u>	<u>25-49</u>	<u>50-99</u>	<u>100+</u>
MC9434-12	12"	34.45	32.75	31.15	29.60
MC9434-24	24"	35.65	33.90	32.20	30.60
MC9434-36	36"	36.85	35.00	33.25	31.60
MC9434-48	48"	38.05	36.15	34.35	32.65
MC9434-60	60"	38.25	36.35	34.55	32.85
MC9434-72	72"	39.45	37.50	35.65	33.90
MC9434-XX	ANY	PRICE UPON REQUEST			

N MALE RIGHT-ANGLE TO N FEMALE BULKHEAD



RG58C/U COAX

<u>MODEL#</u>	<u>LENGTH</u>	<u>1-24</u>	<u>25-49</u>	<u>50-99</u>	<u>100+</u>
MC9262-12	12"	44.00	40.90	37.85	35.20
MC9262-24	24"	44.35	41.25	38.15	35.45
MC9262-36	36"	44.70	41.55	38.40	35.75
MC9262-48	48"	45.00	41.85	38.70	36.00
MC9262-60	60"	45.35	42.20	39.00	36.30
MC9262-72	72"	45.70	42.50	39.30	36.65
MC9262-XX	ANY	PRICE UPON REQUEST			

RG223/U COAX, DOUBLE SHIELDED

<u>MODEL#</u>	<u>LENGTH</u>	<u>1-24</u>	<u>25-49</u>	<u>50-99</u>	<u>100+</u>
MC9266-12	12"	55.00	51.13	47.31	44.00
MC9266-24	24"	56.38	52.44	48.50	45.13
MC9266-36	36"	57.75	53.69	49.69	46.19
MC9266-48	48"	59.13	55.00	50.88	47.31
MC9266-60	60"	60.50	56.25	52.00	48.38
MC9266-72	72"	61.88	57.56	53.19	49.50
MC9266-XX	ANY	PRICE UPON REQUEST			

RG142B/U COAX, DOUBLE SHIELDED

<u>MODEL#</u>	<u>LENGTH</u>	<u>1-24</u>	<u>25-49</u>	<u>50-99</u>	<u>100+</u>
MC9263-12	12"	55.00	51.13	47.31	44.00
MC9263-24	24"	57.75	53.69	49.69	46.19
MC9263-36	36"	60.50	56.26	52.00	48.38
MC9263-48	48"	63.25	58.81	54.44	50.63
MC9263-60	60"	66.00	61.38	56.75	52.81
MC9263-72	72"	68.75	63.94	59.13	55.00
MC9263-XX	ANY	PRICE UPON REQUEST			

RG393/U COAX, DOUBLE SHIELDED

<u>MODEL#</u>	<u>LENGTH</u>	<u>1-24</u>	<u>25-49</u>	<u>50-99</u>	<u>100+</u>
MC9270-12	12"	64.71	60.18	55.65	51.76
MC9270-24	24"	72.94	67.82	62.71	58.35
MC9270-36	36"	81.18	75.47	69.82	64.94
MC9270-48	48"	89.41	83.18	76.88	71.53
MC9270-60	60"	97.65	90.82	84.00	78.12
MC9270-72	72"	105.88	98.47	91.06	84.71
MC9270-XX	ANY	PRICE UPON REQUEST			

RG213/U COAX

<u>MODEL#</u>	<u>LENGTH</u>	<u>1-24</u>	<u>25-49</u>	<u>50-99</u>	<u>100+</u>
MC9264-12	12"	64.71	60.18	55.65	51.76
MC9264-24	24"	65.71	61.11	56.47	52.53
MC9264-36	36"	66.71	62.00	57.35	53.35
MC9264-48	48"	67.65	62.94	58.18	54.12
MC9264-60	60"	68.65	63.82	59.06	54.94
MC9264-72	72"	69.65	64.76	59.88	55.71
MC9264-XX	ANY	PRICE UPON REQUEST			

RG400/U COAX, DOUBLE SHIELDED

<u>MODEL#</u>	<u>LENGTH</u>	<u>1-24</u>	<u>25-49</u>	<u>50-99</u>	<u>100+</u>
MC9271-12	12"	44.00	40.90	37.85	35.20
MC9271-24	24"	46.20	42.95	39.75	36.95
MC9271-36	36"	48.40	45.00	41.60	38.70
MC9271-48	48"	50.60	47.05	43.50	40.50
MC9271-60	60"	52.80	49.10	45.40	42.25
MC9271-72	72"	55.00	51.15	47.30	44.00
MC9271-XX	ANY	PRICE UPON REQUEST			

RG214/U COAX, DOUBLE SHIELDED

<u>MODEL#</u>	<u>LENGTH</u>	<u>1-24</u>	<u>25-49</u>	<u>50-99</u>	<u>100+</u>
MC9265-12	12"	64.71	60.18	55.65	51.76
MC9265-24	24"	68.24	63.47	58.71	54.59
MC9265-36	36"	71.76	66.76	61.71	57.41
MC9265-48	48"	75.29	70.00	64.76	60.24
MC9265-60	60"	78.82	73.29	67.76	63.06
MC9265-72	72"	82.35	76.59	70.82	65.88
MC9265-XX	ANY	PRICE UPON REQUEST			

TIMES LMR-240

<u>MODEL#</u>	<u>LENGTH</u>	<u>1-24</u>	<u>25-49</u>	<u>50-99</u>	<u>100+</u>
MC9433-12	12"	37.10	35.25	33.50	31.85
MC9433-24	24"	38.30	36.40	34.60	32.90
MC9433-36	36"	39.50	37.65	35.80	34.05
MC9433-48	48"	40.70	38.70	36.70	34.90
MC9433-60	60"	41.90	39.80	37.80	35.90
MC9433-72	72"	43.10	40.95	38.90	37.00
MC9433-XX	ANY	PRICE UPON REQUEST			

N MALE TO TNC MALE



RG58C/U COAX

<u>MODEL#</u>	<u>LENGTH</u>	<u>1-24</u>	<u>25-49</u>	<u>50-99</u>	<u>100+</u>
MC9272-12	12"	24.20	22.50	20.80	19.35
MC9272-24	24"	24.55	22.80	21.10	19.65
MC9272-36	36"	24.90	23.15	21.40	19.90
MC9272-48	48"	25.20	23.45	21.70	20.20
MC9272-60	60"	25.55	23.75	22.00	20.45
MC9272-72	72"	25.90	24.10	22.25	20.70
MC9272-XX	ANY	PRICE UPON REQUEST			

RG142B/U COAX, DOUBLE SHIELDED

<u>MODEL#</u>	<u>LENGTH</u>	<u>1-24</u>	<u>25-49</u>	<u>50-99</u>	<u>100+</u>
MC9273-12	12"	30.25	28.13	26.00	24.19
MC9273-24	24"	33.00	30.69	28.38	26.38
MC9273-36	36"	35.75	33.25	30.75	28.63
MC9273-48	48"	38.50	35.81	33.13	30.81
MC9273-60	60"	41.25	38.38	35.50	33.00
MC9273-72	72"	44.00	40.94	37.81	35.19
MC9273-XX	ANY	PRICE UPON REQUEST			

RG174A/U COAX

<u>MODEL#</u>	<u>LENGTH</u>	<u>1-24</u>	<u>25-49</u>	<u>50-99</u>	<u>100+</u>
MC9274-12	12"	35.20	32.75	30.25	28.15
MC9274-24	24"	35.40	32.95	30.45	28.35
MC9274-36	36"	35.65	33.15	30.65	28.50
MC9274-48	48"	35.85	33.35	30.85	28.70
MC9274-60	60"	36.10	33.55	31.05	28.85
MC9274-72	72"	36.30	33.75	31.20	29.05
MC9274-XX	ANY	PRICE UPON REQUEST			

RG214/U COAX, DOUBLE SHIELDED

<u>MODEL#</u>	<u>LENGTH</u>	<u>1-24</u>	<u>25-49</u>	<u>50-99</u>	<u>100+</u>
MC9276-12	12"	42.71	39.71	36.71	34.18
MC9276-24	24"	46.24	43.00	39.76	37.00
MC9276-36	36"	49.76	46.29	42.82	39.82
MC9276-48	48"	53.29	49.59	45.82	41.65
MC9276-60	60"	56.82	52.82	48.88	45.47
MC9276-72	72"	60.35	56.12	51.88	48.29
MC9276-XX	ANY	PRICE UPON REQUEST			

RG223/U COAX, DOUBLE SHIELDED

<u>MODEL#</u>	<u>LENGTH</u>	<u>1-24</u>	<u>25-49</u>	<u>50-99</u>	<u>100+</u>
MC9277-12	12"	30.25	28.13	26.00	24.19
MC9277-24	24"	31.63	29.44	27.19	25.31
MC9277-36	36"	33.00	30.69	28.38	26.38
MC9277-48	48"	34.38	32.00	29.56	27.50
MC9277-60	60"	35.75	33.25	30.75	28.63
MC9277-72	72"	37.13	34.50	31.94	29.69
MC9277-XX	ANY	PRICE UPON REQUEST			

RG316/U COAX

<u>MODEL#</u>	<u>LENGTH</u>	<u>1-24</u>	<u>25-49</u>	<u>50-99</u>	<u>100+</u>
MC9278-12	12"	36.30	33.75	31.20	29.05
MC9278-24	24"	37.10	34.50	31.90	29.70
MC9278-36	36"	37.90	35.25	32.60	30.30
MC9278-48	48"	38.70	36.00	33.30	30.95
MC9278-60	60"	39.50	36.75	33.95	31.60
MC9278-72	72"	40.30	37.50	34.65	32.25
MC9278-XX	ANY	PRICE UPON REQUEST			

RG316-DS COAX, DOUBLE SHIELDED

<u>MODEL#</u>	<u>LENGTH</u>	<u>1-24</u>	<u>25-49</u>	<u>50-99</u>	<u>100+</u>
MC9279-12	12"	38.50	35.80	33.10	30.80
MC9279-24	24"	40.50	37.65	34.85	32.40
MC9279-36	36"	42.50	39.55	36.55	34.00
MC9279-48	48"	44.50	41.40	38.25	35.60
MC9279-60	60"	46.50	43.25	40.00	37.20
MC9279-72	72"	48.50	45.10	41.70	38.80
MC9279-XX	ANY	PRICE UPON REQUEST			

RG393/U COAX, DOUBLE SHIELDED

<u>MODEL#</u>	<u>LENGTH</u>	<u>1-24</u>	<u>25-49</u>	<u>50-99</u>	<u>100+</u>
MC9280-12	12"	42.71	39.71	36.71	34.18
MC9280-24	24"	50.94	47.35	43.82	40.76
MC9280-36	36"	59.18	55.06	50.88	47.35
MC9280-48	48"	67.41	62.71	58.00	53.94
MC9280-60	60"	75.65	70.35	65.06	60.53
MC9280-72	72"	83.88	78.00	72.12	67.12
MC9280-XX	ANY	PRICE UPON REQUEST			

RG400/U COAX, DOUBLE SHIELDED

<u>MODEL#</u>	<u>LENGTH</u>	<u>1-24</u>	<u>25-49</u>	<u>50-99</u>	<u>100+</u>
MC9281-12	12"	24.20	22.50	20.80	19.35
MC9281-24	24"	26.40	24.55	22.70	21.10
MC9281-36	36"	28.60	26.60	24.60	22.90
MC9281-48	48"	30.80	28.65	26.50	24.65
MC9281-60	60"	33.00	30.70	28.40	26.40
MC9281-72	72"	35.20	32.75	30.25	28.15
MC9281-XX	ANY	PRICE UPON REQUEST			

TIMES LMR-240

<u>MODEL#</u>	<u>LENGTH</u>	<u>1-24</u>	<u>25-49</u>	<u>50-99</u>	<u>100+</u>
MC9432-12	12"	26.65	25.35	24.10	22.90
MC9432-24	24"	27.85	26.50	25.20	23.95
MC9432-36	36"	29.05	27.60	26.25	24.95
MC9432-48	48"	30.25	28.75	27.35	26.00
MC9432-60	60"	31.45	29.90	28.40	27.00
MC9432-72	72"	32.65	31.00	29.45	28.00
MC9432-XX	ANY	PRICE UPON REQUEST			

SMB PLUG TO SMB PLUG



RG174A/U COAX

<u>MODEL#</u>	<u>LENGTH</u>	<u>1-24</u>	<u>25-49</u>	<u>50-99</u>	<u>100+</u>
MC9282-12	12"	22.00	20.45	18.90	17.60
MC9282-24	24"	22.20	20.65	19.10	17.80
MC9282-36	36"	22.45	20.85	19.30	17.95
MC9282-48	48"	22.65	21.05	19.50	18.15
MC9282-60	60"	22.90	21.30	19.70	18.30
MC9282-72	72"	23.10	21.50	19.85	18.50
MC9282-XX	ANY	PRICE UPON REQUEST			

RG316/U COAX

<u>MODEL#</u>	<u>LENGTH</u>	<u>1-24</u>	<u>25-49</u>	<u>50-99</u>	<u>100+</u>
MC9285-12	12"	22.00	20.45	18.90	17.60
MC9285-24	24"	22.80	21.20	19.60	18.25
MC9285-36	36"	23.60	21.95	20.30	18.90
MC9285-48	48"	24.40	22.70	21.00	19.50
MC9285-60	60"	25.20	23.45	21.65	20.15
MC9285-72	72"	26.00	24.20	22.35	20.80
MC9285-XX	ANY	PRICE UPON REQUEST			

RG178B/U COAX

<u>MODEL#</u>	<u>LENGTH</u>	<u>1-24</u>	<u>25-49</u>	<u>50-99</u>	<u>100+</u>
MC9283-12	12"	23.10	21.50	19.85	18.50
MC9283-24	24"	23.90	22.25	20.55	19.10
MC9283-36	36"	24.70	22.95	21.25	19.75
MC9283-48	48"	25.50	23.70	21.95	20.40
MC9283-60	60"	26.30	24.45	22.60	21.05
MC9283-72	72"	27.10	25.20	23.30	21.70
MC9283-XX	ANY	PRICE UPON REQUEST			

RG316-DS COAX, DOUBLE SHIELDED

<u>MODEL#</u>	<u>LENGTH</u>	<u>1-24</u>	<u>25-49</u>	<u>50-99</u>	<u>100+</u>
MC9286-12	12"	24.20	22.50	20.80	19.35
MC9286-24	24"	26.20	24.35	22.55	20.95
MC9286-36	36"	28.20	26.25	24.25	22.55
MC9286-48	48"	30.20	28.10	25.95	24.15
MC9286-60	60"	32.20	29.95	27.70	25.75
MC9286-72	72"	34.20	31.80	29.40	27.35
MC9286-XX	ANY	PRICE UPON REQUEST			

TIMES LMR-100A

<u>MODEL#</u>	<u>LENGTH</u>	<u>1-24</u>	<u>25-49</u>	<u>50-99</u>	<u>100+</u>
MC9408-12	12"	25.25	24.00	22.80	21.70
MC9408-24	24"	25.95	24.65	23.45	22.30
MC9408-36	36"	26.65	25.35	24.10	22.90
MC9408-48	48"	27.35	26.00	24.70	23.50
MC9408-60	60"	28.05	26.65	25.35	24.10
MC9408-72	72"	28.75	27.35	26.00	24.70
MC9408-XX	ANY	PRICE UPON REQUEST			

SMB PLUG TO SMB PLUG RIGHT-ANGLE



RG174A/U COAX

<u>MODEL#</u>	<u>LENGTH</u>	<u>1-24</u>	<u>25-49</u>	<u>50-99</u>	<u>100+</u>
MC9287-12	12"	29.70	27.60	25.55	23.75
MC9287-24	24"	29.90	27.85	25.75	23.95
MC9287-36	36"	30.15	28.05	25.90	24.10
MC9287-48	48"	30.35	28.25	26.10	24.30
MC9287-60	60"	30.60	28.45	26.30	24.45
MC9287-72	72"	30.80	28.65	26.50	24.65
MC9287-XX	ANY	PRICE UPON REQUEST			

RG316/U-COAX

<u>MODEL#</u>	<u>LENGTH</u>	<u>1-24</u>	<u>25-49</u>	<u>50-99</u>	<u>100+</u>
MC9290-12	12"	27.50	25.60	23.65	22.00
MC9290-24	24"	28.30	26.30	24.35	22.65
MC9290-36	36"	29.10	27.05	25.05	23.30
MC9290-48	48"	29.90	27.80	25.70	23.90
MC9290-60	60"	30.70	28.55	26.40	24.55
MC9290-72	72"	31.50	29.30	27.10	25.20
MC92990-XX	ANY	PRICE UPON REQUEST			

RG178B/U COAX

<u>MODEL#</u>	<u>LENGTH</u>	<u>1-24</u>	<u>25-49</u>	<u>50-99</u>	<u>100+</u>
MC9288-12	12"	28.60	26.60	24.60	22.90
MC9288-24	24"	29.40	27.35	25.30	23.50
MC9288-36	36"	30.20	28.10	25.95	24.15
MC9288-48	48"	31.00	28.85	26.65	24.80
MC9288-60	60"	31.80	29.55	27.35	25.45
MC9288-72	72"	32.60	30.30	28.05	26.10
MC9288-XX	ANY	PRICE UPON REQUEST			

RG316-DS COAX, DOUBLE SHIELDED

<u>MODEL#</u>	<u>LENGTH</u>	<u>1-24</u>	<u>25-49</u>	<u>50-99</u>	<u>100+</u>
MC9291-12	12"	29.70	27.60	25.55	23.75
MC9291-24	24"	31.70	29.50	27.25	25.35
MC9291-36	36"	33.70	31.35	29.00	26.95
MC9291-48	48"	35.70	33.20	30.70	28.55
MC9291-60	60"	37.70	35.05	32.40	30.15
MC9291-72	72"	39.70	36.90	34.15	31.75
MC9291-XX	ANY	PRICE UPON REQUEST			

TIMES LMR-100A

<u>MODEL#</u>	<u>LENGTH</u>	<u>1-24</u>	<u>25-49</u>	<u>50-99</u>	<u>100+</u>
MC9409-12	12"	27.25	25.90	24.60	23.40
MC9409-24	24"	27.95	26.55	25.25	24.00
MC9409-36	36"	28.65	27.25	25.90	24.60
MC9409-48	48"	29.35	27.90	26.50	25.20
MC9409-60	60"	30.05	28.55	27.15	25.80
MC9409-72	72"	30.75	29.25	27.80	26.45
MC9409-XX	ANY	PRICE UPON REQUEST			



RG174A/U COAX

<u>MODEL#</u>	<u>LENGTH</u>	<u>1-24</u>	<u>25-49</u>	<u>50-99</u>	<u>100+</u>
MC9292-12	12"	29.70	27.60	25.55	23.75
MC9292-24	24"	29.90	27.85	25.75	23.95
MC9292-36	36"	30.15	28.05	25.90	24.10
MC9292-48	48"	30.35	28.25	26.10	24.30
MC9292-60	60"	30.60	28.45	26.30	24.45
MC9292-72	72"	30.80	28.65	26.50	24.65
MC9292-XX	ANY	PRICE UPON REQUEST			

RG316/U COAX

<u>MODEL#</u>	<u>LENGTH</u>	<u>1-24</u>	<u>25-49</u>	<u>50-99</u>	<u>100+</u>
MC9295-12	12"	29.70	27.60	25.55	23.75
MC9295-24	24"	30.50	28.35	26.25	24.40
MC9295-36	36"	31.30	29.10	26.90	25.05
MC9295-48	48"	32.10	29.85	27.60	25.70
MC9295-60	60"	32.90	30.60	28.30	26.30
MC9295-72	72"	33.70	31.35	29.00	26.95
MC9295-XX	ANY	PRICE UPON REQUEST			

RG178B/U COAX

<u>MODEL#</u>	<u>LENGTH</u>	<u>1-24</u>	<u>25-49</u>	<u>50-99</u>	<u>100+</u>
MC9293-12	12"	30.80	28.65	26.50	24.65
MC9293-24	24"	31.60	29.40	27.20	25.30
MC9293-36	36"	32.40	30.15	27.85	25.90
MC9293-48	48"	33.20	30.90	28.55	26.55
MC9293-60	60"	34.00	31.60	29.25	27.20
MC9293-72	72"	34.80	32.35	29.95	27.85
MC9293-XX	ANY	PRICE UPON REQUEST			

RG316-DS COAX, DOUBLE SHIELDED

<u>MODEL#</u>	<u>LENGTH</u>	<u>1-24</u>	<u>25-49</u>	<u>50-99</u>	<u>100+</u>
MC9296-12	12"	31.90	29.65	27.45	25.50
MC9296-24	24"	33.90	31.55	29.15	27.10
MC9296-36	36"	35.90	33.40	30.85	28.70
MC9296-48	48"	37.90	35.25	32.60	30.30
MC9296-60	60"	39.90	37.10	34.30	31.90
MC9296-72	72"	41.90	38.95	36.05	33.50
MC9296-XX	ANY	PRICE UPON REQUEST			

TIMES LMR-100A

<u>MODEL#</u>	<u>LENGTH</u>	<u>1-24</u>	<u>25-49</u>	<u>50-99</u>	<u>100+</u>
MC9410-12	12"	29.30	27.85	26.45	25.15
MC9410-24	24"	30.00	28.50	27.10	25.75
MC9410-36	36"	30.70	29.20	27.75	26.40
MC9410-48	48"	31.40	29.85	28.35	26.95
MC9410-60	60"	32.10	30.50	29.00	27.55
MC9410-72	72"	32.80	31.20	29.65	28.20
MC9410-XX	ANY	PRICE UPON REQUEST			

SMB PLUG TO SMB JACK BULKHEAD



RG174A/U COAX

<u>MODEL#</u>	<u>LENGTH</u>	<u>1-24</u>	<u>25-49</u>	<u>50-99</u>	<u>100+</u>
MC9297-12	12"	29.70	27.60	25.55	23.75
MC9297-24	24"	29.90	27.85	25.75	23.95
MC9297-36	36"	30.15	28.05	25.90	24.10
MC9297-48	48"	30.35	28.25	26.10	24.30
MC9297-60	60"	30.60	28.45	26.30	24.45
MC9297-72	72"	30.80	28.65	26.50	24.65
MC9297-XX	ANY	PRICE UPON REQUEST			

RG316/U COAX

<u>MODEL#</u>	<u>LENGTH</u>	<u>1-24</u>	<u>25-49</u>	<u>50-99</u>	<u>100+</u>
MC9300-12	12"	27.50	25.60	23.65	22.00
MC9300-24	24"	28.30	26.30	24.35	22.65
MC9300-36	36"	29.10	27.05	25.05	23.30
MC9300-48	48"	29.90	27.80	25.70	23.90
MC9300-60	60"	30.70	28.55	26.40	24.55
MC9300-72	72"	31.50	29.30	27.10	25.20
MC9300-XX	ANY	PRICE UPON REQUEST			

RG178B/U COAX

<u>MODEL#</u>	<u>LENGTH</u>	<u>1-24</u>	<u>25-49</u>	<u>50-99</u>	<u>100+</u>
MC9298-12	12"	30.80	28.65	26.50	24.65
MC9298-24	24"	31.60	29.40	27.20	25.30
MC9298-36	36"	32.40	30.15	27.85	25.90
MC9298-48	48"	33.20	30.90	28.55	26.55
MC9298-60	60"	34.00	31.60	29.25	27.20
MC9298-72	72"	34.80	32.35	29.95	27.85
MC9298-XX	ANY	PRICE UPON REQUEST			

RG316-DS COAX, DOUBLE SHIELDED

<u>MODEL#</u>	<u>LENGTH</u>	<u>1-24</u>	<u>25-49</u>	<u>50-99</u>	<u>100+</u>
MC9301-12	12"	29.70	27.60	25.55	23.75
MC9301-24	24"	31.70	29.50	27.25	25.35
MC9301-36	36"	33.70	31.35	29.00	26.95
MC9301-48	48"	35.70	33.20	30.70	28.55
MC9301-60	60"	37.70	35.05	32.40	30.15
MC9301-72	72"	39.70	36.90	34.15	31.75
MC9301-XX	ANY	PRICE UPON REQUEST			

TIMES LMR-100A

<u>MODEL#</u>	<u>LENGTH</u>	<u>1-24</u>	<u>25-49</u>	<u>50-99</u>	<u>100+</u>
MC9411-12	12"	27.80	26.45	25.15	23.90
MC9411-24	24"	28.50	27.10	25.75	24.50
MC9411-36	36"	29.20	27.75	26.40	25.10
MC9411-48	48"	29.70	28.25	26.85	25.50
MC9411-60	60"	30.40	28.90	27.50	26.15
MC9411-72	72"	31.10	29.60	28.15	26.75
MC9411-XX	ANY	PRICE UPON REQUEST			

SMB PLUG RIGHT-ANGLE TO SMB JACK BULKHEAD



RG174A/U COAX

<u>MODEL#</u>	<u>LENGTH</u>	<u>1-24</u>	<u>25-49</u>	<u>50-99</u>	<u>100+</u>
MC9302-12	12"	29.70	27.60	25.55	23.75
MC9302-24	24"	29.90	27.85	25.75	23.95
MC9302-36	36"	30.15	28.05	25.90	24.10
MC9302-48	48"	30.35	28.25	26.10	24.30
MC9302-60	60"	30.60	28.45	26.30	24.45
MC9302-72	72"	30.80	28.65	26.50	24.65
MC9302-XX	ANY	PRICE UPON REQUEST			

RG316/U COAX

<u>MODEL#</u>	<u>LENGTH</u>	<u>1-24</u>	<u>25-49</u>	<u>50-99</u>	<u>100+</u>
MC9305-12	12"	29.70	27.60	25.55	23.75
MC9305-24	24"	30.50	28.35	26.25	24.40
MC9305-36	36"	31.30	29.10	26.90	25.05
MC9305-48	48"	32.10	29.85	27.60	25.70
MC9305-60	60"	32.90	30.60	28.30	26.30
MC9305-72	72"	33.70	31.35	29.00	26.95
MC9305-XX	ANY	PRICE UPON REQUEST			

RG178B/U COAX

<u>MODEL#</u>	<u>LENGTH</u>	<u>1-24</u>	<u>25-49</u>	<u>50-99</u>	<u>100+</u>
MC9303-12	12"	33.00	30.70	28.40	26.40
MC9303-24	24"	33.80	31.45	29.05	27.05
MC9303-36	36"	34.60	32.20	29.75	27.70
MC9303-48	48"	35.40	32.90	30.45	28.30
MC9303-60	60"	36.20	33.65	31.15	28.95
MC9303-72	72"	37.00	34.40	31.80	29.60
MC9303-XX	ANY	PRICE UPON REQUEST			

RG316-DS COAX, DOUBLE SHIELDED

<u>MODEL#</u>	<u>LENGTH</u>	<u>1-24</u>	<u>25-49</u>	<u>50-99</u>	<u>100+</u>
MC9306-12	12"	31.90	29.65	27.45	25.50
MC9306-24	24"	33.90	31.55	29.15	27.10
MC9306-36	36"	35.90	33.40	30.85	28.70
MC9306-48	48"	37.90	35.25	32.60	30.30
MC9306-60	60"	39.90	37.10	34.30	31.90
MC9306-72	72"	41.90	38.95	36.05	33.50
MC9306-XX	ANY	PRICE UPON REQUEST			

TIMES LMR-100A

<u>MODEL#</u>	<u>LENGTH</u>	<u>1-24</u>	<u>25-49</u>	<u>50-99</u>	<u>100+</u>
MC9412-12	12"	27.80	26.45	25.15	23.90
MC9412-24	24"	28.50	27.10	25.75	24.50
MC9412-36	36"	29.20	27.75	26.40	25.10
MC9412-48	48"	29.70	28.25	26.85	25.50
MC9412-60	60"	30.40	28.90	27.50	26.15
MC9412-72	72"	31.10	29.60	28.15	26.75
MC9412-XX	ANY	PRICE UPON REQUEST			

SMA MALE TO SMB PLUG



RG174A/U COAX

<u>MODEL#</u>	<u>LENGTH</u>	<u>1-24</u>	<u>25-49</u>	<u>50-99</u>	<u>100+</u>
MC9307-6	6"	29.70	27.60	25.55	23.75
MC9307-12	12"	29.80	27.70	25.65	23.85
MC9307-18	18"	29.90	27.85	25.75	23.95
MC9307-24	24"	30.05	27.95	25.85	24.00
MC9307-36	36"	30.25	28.15	26.00	24.20
MC9307-48	48"	30.45	28.35	26.20	24.40
MC9307-60	60"	30.70	28.55	26.40	24.55
MC9307-72	72"	30.90	28.75	26.60	24.75
MC9307-XX	ANY	PRICE UPON REQUEST			

RG316/U COAX

<u>MODEL#</u>	<u>LENGTH</u>	<u>1-24</u>	<u>25-49</u>	<u>50-99</u>	<u>100+</u>
MC9310-6	6"	29.70	27.60	25.55	23.75
MC9310-12	12"	30.10	28.00	25.90	24.10
MC9310-18	18"	30.50	28.35	26.25	24.40
MC9310-24	24"	30.90	28.75	26.55	24.70
MC9310-36	36"	31.70	29.50	27.25	25.35
MC9310-48	48"	32.50	30.25	27.95	26.00
MC9310-60	60"	33.30	30.95	28.65	26.65
MC9310-72	72"	34.10	31.70	29.35	27.30
MC9310-XX	ANY	PRICE UPON REQUEST			

RG178B/U COAX

<u>MODEL#</u>	<u>LENGTH</u>	<u>1-24</u>	<u>25-49</u>	<u>50-99</u>	<u>100+</u>
MC9308-6	6"	41.80	38.85	35.95	33.45
MC9308-12	12"	42.20	39.25	36.30	33.75
MC9308-18	18"	42.60	39.60	36.65	34.10
MC9308-24	24"	43.00	40.00	37.00	34.40
MC9308-36	36"	43.80	40.75	37.65	35.05
MC9308-48	48"	44.60	41.50	38.35	35.70
MC9308-60	60"	45.40	42.20	39.05	36.30
MC9308-72	72"	46.20	42.95	39.75	36.95
MC9308-XX	ANY	PRICE UPON REQUEST			

RG316-DS COAX, DOUBLE SHIELDED

<u>MODEL#</u>	<u>LENGTH</u>	<u>1-24</u>	<u>25-49</u>	<u>50-99</u>	<u>100+</u>
MC9311-6	6"	31.90	29.65	27.45	25.50
MC9311-12	12"	32.90	30.60	28.30	26.30
MC9311-18	18"	33.90	31.55	29.15	27.10
MC9311-24	24"	34.90	32.45	30.00	27.90
MC9311-36	36"	36.90	34.30	31.75	29.50
MC9311-48	48"	38.90	36.20	33.45	31.10
MC9311-60	60"	40.90	38.05	35.15	32.70
MC9311-72	72"	42.90	39.90	36.90	34.30
MC9311-XX	ANY	PRICE UPON REQUEST			

TIMES LMR-100A

<u>MODEL#</u>	<u>LENGTH</u>	<u>1-24</u>	<u>25-49</u>	<u>50-99</u>	<u>100+</u>
MC9413-12	12"	25.10	23.85	22.70	21.60
MC9413-24	24"	25.80	24.55	23.40	22.25
MC9413-36	36"	26.50	25.25	24.00	22.80
MC9413-48	48"	27.20	25.85	24.60	23.40
MC9413-60	60"	27.90	26.50	25.20	23.95
MC9413-72	72"	30.60	29.15	27.70	26.35
MC9413-XX	ANY	PRICE UPON REQUEST			

SSMB PLUG TO SSMB PLUG



STRAIGHT/STRAIGHT

RG178B/U COAX

<u>MODEL#</u>	<u>LENGTH</u>	<u>1-24</u>	<u>25-49</u>	<u>50-99</u>	<u>100+</u>
MC9312-12	12"	34.10	31.70	29.35	27.30
MC9312-24	24"	34.90	32.45	30.00	27.90
MC9312-36	36"	35.70	33.20	30.70	28.55
MC9312-48	48"	36.50	33.95	31.40	29.20
MC9312-60	60"	37.30	34.70	32.10	29.85
MC9312-72	72"	38.10	35.45	32.75	30.50
MC9312-XX	ANY	PRICE UPON REQUEST			

RG316B/U COAX

<u>MODEL#</u>	<u>LENGTH</u>	<u>1-24</u>	<u>25-49</u>	<u>50-99</u>	<u>100+</u>
MC9313-12	12"	33.00	30.70	28.40	26.40
MC9313-24	24"	33.80	31.45	29.05	27.05
MC9313-36	36"	34.60	32.20	29.75	27.70
MC9313-48	48"	35.40	32.90	30.45	28.30
MC9313-60	60"	36.20	33.65	31.15	28.95
MC9313-72	72"	37.00	34.40	31.80	29.60
MC9313-XX	ANY	PRICE UPON REQUEST			

TIMES LMR-100A

<u>MODEL#</u>	<u>LENGTH</u>	<u>1-24</u>	<u>25-49</u>	<u>50-99</u>	<u>100+</u>
MC9414-12	12"	33.00	30.70	28.40	26.40
MC9414-24	24"	33.80	31.45	29.05	27.05
MC9414-36	36"	34.60	32.20	29.75	27.70
MC9414-48	48"	35.40	32.90	30.45	28.30
MC9414-60	60"	36.20	33.65	31.15	28.95
MC9414-72	72"	37.00	34.40	31.80	29.60
MC9414-XX	ANY	PRICE UPON REQUEST			



RIGHT-ANGLE/RIGHT-ANGLE

RG178B/U COAX

<u>MODEL#</u>	<u>LENGTH</u>	<u>1-24</u>	<u>25-49</u>	<u>50-99</u>	<u>100+</u>
MC9314-12	12"	39.60	36.85	34.05	31.70
MC9314-24	24"	40.40	37.55	34.75	32.30
MC9314-36	36"	41.20	38.30	35.45	32.95
MC9314-48	48"	42.00	39.05	36.10	33.60
MC9314-60	60"	42.80	39.80	36.80	34.25
MC9314-72	72"	43.60	40.55	37.50	34.90
MC9314-XX	ANY	PRICE UPON REQUEST			

RG316/U COAX

<u>MODEL#</u>	<u>LENGTH</u>	<u>1-24</u>	<u>25-49</u>	<u>50-99</u>	<u>100+</u>
MC9315-12	12"	38.50	35.80	33.10	30.80
MC9315-24	24"	39.30	36.55	33.80	31.45
MC9315-36	36"	40.10	37.30	34.50	32.10
MC9315-48	48"	40.90	38.05	35.15	32.70
MC9315-60	60"	41.70	38.80	35.85	33.35
MC9315-72	72"	42.50	39.55	36.55	34.00
MC9315-XX	ANY	PRICE UPON REQUEST			

TIMES LMR-100A

<u>MODEL#</u>	<u>LENGTH</u>	<u>1-24</u>	<u>25-49</u>	<u>50-99</u>	<u>100+</u>
MC9415-12	12"	38.50	35.80	33.10	30.80
MC9415-24	24"	39.30	36.35	33.80	31.45
MC9415-36	36"	40.10	37.30	34.50	32.10
MC9415-48	48"	40.90	38.05	35.15	32.70
MC9415-60	60"	41.70	38.80	35.85	33.35
MC9415-72	72"	42.50	39.55	36.55	34.00
MC9415-XX	ANY	PRICE UPON REQUEST			

MCX PLUG TO MCX PLUG



STRAIGHT/STRAIGHT

RG174A/U COAX

<u>MODEL#</u>	<u>LENGTH</u>	<u>1-24</u>	<u>25-49</u>	<u>50-99</u>	<u>100+</u>
MC9316-12	12"	20.90	19.45	17.95	16.70
MC9316-24	24"	21.10	19.65	18.15	16.90
MC9316-36	36"	21.35	19.85	18.35	17.05
MC9316-48	48"	21.55	20.05	18.55	17.25
MC9316-60	60"	21.80	20.25	18.90	17.60
MC9316-72	72"	22.00	20.45	18.90	17.60
MC9316-XX	ANY	PRICE UPON REQUEST			

RG178B/U COAX

<u>MODEL#</u>	<u>LENGTH</u>	<u>1-24</u>	<u>25-49</u>	<u>50-99</u>	<u>100+</u>
MC9317-12	12"	22.00	20.45	18.90	17.60
MC9317-24	24"	22.80	21.20	19.60	18.25
MC9317-36	36"	23.60	21.95	20.30	18.90
MC9317-48	48"	24.40	22.70	21.00	19.50
MC9317-60	60"	25.20	23.45	21.65	20.15
MC9317-72	72"	26.00	24.20	22.35	20.80
MC9317-XX	ANY	PRICE UPON REQUEST			

RG316/U COAX

<u>MODEL#</u>	<u>LENGTH</u>	<u>1-24</u>	<u>25-49</u>	<u>50-99</u>	<u>100+</u>
MC9318-12	12"	20.90	19.45	17.95	16.70
MC9318-24	24"	21.70	20.20	18.65	17.35
MC9318-36	36"	22.50	20.95	19.35	18.00
MC9318-48	48"	23.30	21.65	20.05	18.65
MC9318-60	60"	24.10	22.40	20.75	19.30
MC9318-72	72"	24.90	23.15	21.40	19.90
MC9318-XX	ANY	PRICE UPON REQUEST			



RIGHT-ANGLE/RIGHT-ANGLE

RG174A/U COAX

<u>MODEL#</u>	<u>LENGTH</u>	<u>1-24</u>	<u>25-49</u>	<u>50-99</u>	<u>100+</u>
MC9320-12	12"	28.60	26.60	24.60	22.90
MC9320-24	24"	28.80	26.80	24.80	23.05
MC9320-36	36"	29.05	27.00	24.95	23.25
MC9320-48	48"	29.25	27.20	25.15	23.40
MC9320-60	60"	29.50	27.40	25.35	23.60
MC9320-72	72"	29.70	27.60	25.55	23.75
MC9320-XX	ANY	PRICE UPON REQUEST			

RG178B/U COAX

<u>MODEL#</u>	<u>LENGTH</u>	<u>1-24</u>	<u>25-49</u>	<u>50-99</u>	<u>100+</u>
MC9321-12	12"	29.70	27.60	25.55	23.75
MC9321-24	24"	30.50	28.35	26.25	24.40
MC9321-36	36"	31.30	29.10	26.90	25.05
MC9321-48	48"	32.10	29.85	27.60	25.70
MC9321-60	60"	32.90	30.60	28.30	26.30
MC9321-72	72"	33.70	31.35	29.00	26.95
MC9321-XX	ANY	PRICE UPON REQUEST			

RG316/U COAX

<u>MODEL#</u>	<u>LENGTH</u>	<u>1-24</u>	<u>25-49</u>	<u>50-99</u>	<u>100+</u>
MC9322-12	12"	28.60	26.60	24.60	22.90
MC9322-24	24"	29.40	27.35	25.30	23.50
MC9322-36	36"	30.20	28.10	25.95	24.15
MC9322-48	48"	31.00	28.85	26.65	24.80
MC9322-60	60"	31.80	29.55	27.35	25.45
MC9322-72	72"	32.60	30.30	28.05	26.10
MC9322-XX	ANY	PRICE UPON REQUEST			



MCX PLUG TO MCX PLUG RIGHT-ANGLE

RG174A/U COAX

<u>MODEL#</u>	<u>LENGTH</u>	<u>1-24</u>	<u>25-49</u>	<u>50-99</u>	<u>100+</u>
MC9319-12	12"	27.50	25.60	23.65	22.00
MC9319-24	24"	27.70	25.80	23.85	22.20
MC9319-36	36"	27.95	26.00	24.05	22.35
MC9319-48	48"	28.15	26.20	24.20	22.55
MC9319-60	60"	28.40	26.40	24.40	22.70
MC9319-72	72"	28.60	26.60	24.60	22.90
MC9319-XX	ANY	PRICE UPON REQUEST			

RG178B/U COAX

<u>MODEL#</u>	<u>LENGTH</u>	<u>1-24</u>	<u>25-49</u>	<u>50-99</u>	<u>100+</u>
MC9323-12	12"	28.60	26.60	24.60	22.90
MC9323-24	24"	29.40	27.35	25.30	23.50
MC9323-36	36"	30.20	28.10	25.95	24.15
MC9323-48	48"	31.00	28.85	26.65	24.80
MC9323-60	60"	31.80	29.55	27.35	25.45
MC9323-72	72"	32.60	30.30	28.05	26.10
MC9323-XX	ANY	PRICE UPON REQUEST			

RG316/U COAX

<u>MODEL#</u>	<u>LENGTH</u>	<u>1-24</u>	<u>25-49</u>	<u>50-99</u>	<u>100+</u>
MC9324-12	12"	27.50	25.60	23.65	22.00
MC9324-24	24"	28.30	26.30	24.35	22.65
MC9324-36	36"	29.10	27.05	25.05	23.30
MC9324-48	48"	29.90	27.80	25.70	23.90
MC9324-60	60"	30.70	28.55	26.40	24.55
MC9324-72	72"	31.50	29.30	27.10	25.20
MC9324-XX	ANY	PRICE UPON REQUEST			

TIMES LMR-100A

<u>MODEL#</u>	<u>LENGTH</u>	<u>1-24</u>	<u>25-49</u>	<u>50-99</u>	<u>100+</u>
MC9416-12	12"	27.50	25.60	23.65	22.00
MC9416-24	24"	28.30	26.30	24.35	22.65
MC9416-36	36"	29.10	27.05	25.05	23.30
MC9416-48	48"	29.90	27.80	25.70	23.90
MC9416-60	60"	30.70	28.55	26.40	24.55
MC9416-72	72"	31.50	29.30	27.10	25.20
MC9416-XX	ANY	PRICE UPON REQUEST			

TNC MALE TO TNC MALE



RG58C/U COAX

<u>MODEL#</u>	<u>LENGTH</u>	<u>1-24</u>	<u>25-49</u>	<u>50-99</u>	<u>100+</u>
MC9326-12	12"	18.70	17.40	16.10	14.95
MC9326-18	18"	18.85	17.55	16.25	15.10
MC9326-24	24"	19.05	17.70	16.35	15.25
MC9326-30	30"	19.20	17.85	16.50	15.35
MC9326-36	36"	19.40	18.00	16.65	15.50
MC9326-48	48"	19.70	18.35	16.95	15.80
MC9326-60	60"	20.05	18.65	17.25	16.05
MC9326-72	72"	20.40	18.95	17.55	16.30
MC9326-XX	ANY	PRICE UPON REQUEST			

RG223/U COAX, DOUBLE SHIELDED

<u>MODEL#</u>	<u>LENGTH</u>	<u>1-24</u>	<u>25-49</u>	<u>50-99</u>	<u>100+</u>
MC9329-12	12"	27.50	25.56	23.63	22.00
MC9329-24	24"	28.88	26.88	24.81	23.13
MC9329-36	36"	30.25	28.13	26.00	24.19
MC9329-48	48"	31.63	29.44	27.19	25.31
MC9329-60	60"	33.00	30.69	28.38	26.38
MC9329-72	72"	34.38	32.00	29.56	27.50
MC9329-XX	ANY	PRICE UPON REQUEST			

RG142B/U COAX, DOUBLE SHIELDED

<u>MODEL#</u>	<u>LENGTH</u>	<u>1-24</u>	<u>25-49</u>	<u>50-99</u>	<u>100+</u>
MC9327-12	12"	27.50	25.56	23.63	22.00
MC9327-24	24"	30.25	28.13	26.00	24.19
MC9327-36	36"	33.00	30.69	28.38	26.38
MC9327-48	48"	35.75	33.25	30.75	28.63
MC9327-60	60"	38.50	35.81	33.13	30.81
MC9327-72	72"	41.25	38.38	35.50	33.00
MC9327-XX	ANY	PRICE UPON REQUEST			

RG316/U COAX

<u>MODEL#</u>	<u>LENGTH</u>	<u>1-24</u>	<u>25-49</u>	<u>50-99</u>	<u>100+</u>
MC9330-12	12"	23.10	21.50	19.85	18.50
MC9330-24	24"	23.90	22.25	20.55	19.10
MC9330-36	36"	24.70	22.95	21.25	19.75
MC9330-48	48"	25.50	23.70	21.95	20.40
MC9330-60	60"	26.30	24.45	22.60	21.05
MC9330-72	72"	27.10	25.20	23.30	21.70
MC9330-XX	ANY	PRICE UPON REQUEST			

RG174A/U COAX

<u>MODEL#</u>	<u>LENGTH</u>	<u>1-24</u>	<u>25-49</u>	<u>50-99</u>	<u>100+</u>
MC9328-12	12"	18.70	17.40	16.10	14.95
MC9328-24	24"	18.90	17.60	16.25	15.15
MC9328-36	36"	19.15	17.80	16.45	15.30
MC9328-48	48"	19.35	18.00	16.65	15.50
MC9328-60	60"	19.60	18.20	16.85	15.65
MC9328-72	72"	19.80	18.40	17.05	15.85
MC9328-XX	ANY	PRICE UPON REQUEST			

RG400/U COAX, DOUBLE SHIELDED

<u>MODEL#</u>	<u>LENGTH</u>	<u>1-24</u>	<u>25-49</u>	<u>50-99</u>	<u>100+</u>
MC9331-12	12"	22.00	20.45	18.90	17.60
MC9331-24	24"	24.20	22.50	20.80	19.35
MC9331-36	36"	26.40	24.55	22.70	21.10
MC9331-48	48"	28.60	26.60	24.60	22.90
MC9331-60	60"	30.80	28.65	26.50	24.65
MC9331-72	72"	33.00	30.70	28.40	26.40
MC9331-XX	ANY	PRICE UPON REQUEST			

TIMES LMR-100

<u>MODEL#</u>	<u>LENGTH</u>	<u>1-24</u>	<u>25-49</u>	<u>50-99</u>	<u>100+</u>
MC9417-12	12"	18.70	17.40	16.10	14.95
MC9417-24	24"	19.40	18.10	16.80	15.65
MC9417-36	36"	20.10	18.80	17.50	16.35
MC9417-48	48"	20.80	19.50	18.20	17.05
MC9417-60	60"	21.50	20.20	18.90	17.75
MC9417-72	72"	22.20	20.90	19.60	18.45
MC9417-XX	ANY	PRICE UPON REQUEST			

TIMES LMR-240

<u>MODEL#</u>	<u>LENGTH</u>	<u>1-24</u>	<u>25-49</u>	<u>50-99</u>	<u>100+</u>
MC9418-12	12"	18.70	17.40	16.10	14.95
MC9418-24	24"	19.40	18.10	16.80	15.65
MC9418-36	36"	20.10	18.80	17.50	16.35
MC9418-48	48"	20.80	19.50	18.20	17.05
MC9418-60	60"	21.50	20.20	18.90	17.75
MC9418-72	72"	22.20	20.90	19.60	18.45
MC9418-XX	ANY	PRICE UPON REQUEST			

SMA MALE TO TNC MALE



RG58 C/U COAX

<u>MODEL#</u>	<u>LENGTH</u>	<u>1-24</u>	<u>25-49</u>	<u>50-99</u>	<u>100+</u>
MC 9363-12	12"	27.85	25.90	23.95	22.30
MC 9363-24	24"	28.25	26.25	24.30	22.60
MC 9363-36	36"	28.60	26.60	24.60	22.90
MC 9363-48	48"	28.95	26.90	24.90	23.15
MC 9363-60	60"	29.30	27.25	25.20	23.45
MC 9363-72	72"	29.70	27.65	25.60	23.86
MC 9363-XX	ANY	PRICE UPON REQUEST			

RG316/U COAX

<u>MODEL#</u>	<u>LENGTH</u>	<u>1-24</u>	<u>25-49</u>	<u>50-99</u>	<u>100+</u>
MC 9367-12	12"	31.35	29.15	26.95	25.05
MC 9367-24	24"	32.20	29.95	27.70	25.75
MC 9367-36	36"	33.05	30.70	28.40	26.40
MC 9367-48	48"	33.85	31.50	29.15	27.10
MC 9367-60	60"	34.70	32.30	29.35	27.80
MC 9367-72	72"	35.50	33.10	30.65	28.60
MC 9367-XX	ANY	PRICE UPON REQUEST			

RG142 COAX, DOUBLE SHIELDED

<u>MODEL#</u>	<u>LENGTH</u>	<u>1-24</u>	<u>25-49</u>	<u>50-99</u>	<u>100+</u>
MC 9364-12	12"	34.81	32.38	29.94	27.88
MC 9364-24	24"	37.75	35.13	32.44	30.19
MC 9364-36	36"	40.63	37.81	34.94	32.50
MC 9364-48	48"	43.56	40.50	37.44	34.88
MC 9364-60	60"	46.44	43.19	39.94	37.19
MC 9364-72	72"	49.56	46.31	43.06	40.31
MC 9364-XX	ANY	PRICE UPON REQUEST			

RD316 COAX DOUBLE SHIELDED

<u>MODEL#</u>	<u>LENGTH</u>	<u>1-24</u>	<u>25-49</u>	<u>50-99</u>	<u>100+</u>
MC 9368-12	12"	33.65	31.30	28.95	26.95
MC 9368-24	24"	35.80	33.30	30.75	28.60
MC 9368-36	36"	37.90	36.25	32.60	30.30
MC 9368-48	48"	40.00	37.20	34.40	32.00
MC 9368-60	60"	42.10	39.15	36.20	33.70
MC 9368-72	72"	44.10	41.15	38.20	35.70
MC 9368-XX	ANY	PRICE UPON REQUEST			

RG174 A/U COAX

<u>MODEL#</u>	<u>LENGTH</u>	<u>1-24</u>	<u>25-49</u>	<u>50-99</u>	<u>100+</u>
MC 9365-12	12"	31.35	29.15	26.95	25.10
MC 9365-24	24"	31.60	29.35	27.15	25.25
MC 9365-36	36"	31.80	29.60	27.35	25.45
MC 9365-48	48"	32.05	29.80	27.55	25.65
MC 9365-60	60"	32.25	30.00	27.75	25.80
MC 9365-72	72"	32.50	30.25	28.00	26.10
MC 9365-XX	ANY	PRICE UPON REQUEST			

RG400/U COAX U DOUBLE SHIELDED

<u>MODEL#</u>	<u>LENGTH</u>	<u>1-24</u>	<u>25-49</u>	<u>50-99</u>	<u>100+</u>
MC 9369-12	12"	27.85	25.90	23.95	22.30
MC 9369-24	24"	30.20	28.10	25.95	24.15
MC 9369-36	36"	32.50	30.25	27.95	26.00
MC 9369-48	48"	34.85	32.40	29.95	27.85
MC 9369-60	60"	37.15	34.55	31.95	29.75
MC 9369-72	72"	39.65	37.05	34.45	32.25
MC 9369-XX	ANY	PRICE UPON REQUEST			

RG223/U COAX, DOUBLE SHIELDED

<u>MODEL#</u>	<u>LENGTH</u>	<u>1-24</u>	<u>25-49</u>	<u>50-99</u>	<u>100+</u>
MC 9366-12	12"	34.81	32.38	29.94	27.88
MC 9366-24	24"	36.31	33.69	31.19	29.06
MC 9366-36	36"	37.75	35.13	32.44	30.19
MC 9366-48	48"	39.19	36.44	33.69	31.38
MC 9366-60	60"	40.63	37.81	34.94	32.50
MC 9366-72	72"	42.13	39.31	36.44	34.06
MC 9366-XX	ANY	PRICE UPON REQUEST			

TIMES LMR-240

<u>MODEL#</u>	<u>LENGTH</u>	<u>1-24</u>	<u>25-49</u>	<u>50-99</u>	<u>100+</u>
MC9420-12	12"	27.85	25.90	23.95	22.30
MC9420-24	24"	28.55	26.60	24.65	23.00
MC9420-36	36"	29.25	27.30	25.35	23.70
MC9420-48	48"	30.00	28.00	26.05	24.40
MC9420-60	60"	30.75	28.70	26.75	25.10
MC9420-72	72"	31.50	29.40	27.45	25.80
MC9420-XX	ANY	PRICE UPON REQUEST			

TIMES LMR-100A

<u>MODEL#</u>	<u>LENGTH</u>	<u>1-24</u>	<u>25-49</u>	<u>50-99</u>	<u>100+</u>
MC9419-12	12"	31.35	29.15	26.95	25.05
MC9419-24	24"	32.20	29.95	27.70	25.75
MC9419-36	36"	33.05	31.50	29.15	27.10
MC9419-48	48"	33.85	31.50	29.15	27.10
MC9419-60	60"	34.70	32.30	29.85	27.80
MC9419-72	72"	25.50	33.10	30.65	28.60
MC9419-XX	ANY	PRICE UPON REQUEST			

SMC PLUG TO SMC PLUG



RG174A/U COAX

<u>MODEL#</u>	<u>LENGTH</u>	<u>1-24</u>	<u>25-49</u>	<u>50-99</u>	<u>100+</u>
MC9332-12	12"	22.00	20.45	18.90	17.60
MC9332-24	24"	22.20	20.65	19.10	17.80
MC9332-36	36"	22.45	20.85	19.30	17.95
MC9332-48	48"	22.65	21.05	19.50	18.15
MC9332-60	60"	22.90	21.30	19.70	18.30
MC9332-72	72"	23.10	21.50	19.85	18.50
MC9332-XX	ANY	PRICE UPON REQUEST			

RG316/U COAX

<u>MODEL#</u>	<u>LENGTH</u>	<u>1-24</u>	<u>25-49</u>	<u>50-99</u>	<u>100+</u>
MC9335-12	12"	22.00	20.45	18.90	17.60
MC9335-24	24"	22.80	21.20	19.60	18.25
MC9335-36	36"	23.60	21.95	20.30	18.90
MC9335-48	48"	24.40	22.70	21.00	19.50
MC9335-60	60"	25.20	23.45	21.65	20.15
MC9335-72	72"	26.00	24.20	22.35	20.80
MC9335-XX	ANY	PRICE UPON REQUEST			

RG178B/U COAX

<u>MODEL#</u>	<u>LENGTH</u>	<u>1-24</u>	<u>25-49</u>	<u>50-99</u>	<u>100+</u>
MC9333-12	12"	23.10	21.50	19.85	18.50
MC9333-24	24"	23.90	22.25	20.55	19.10
MC9333-36	36"	24.70	22.95	21.25	19.75
MC9333-48	48"	25.50	23.70	21.95	20.40
MC9333-60	60"	26.30	24.45	22.60	21.05
MC9333-72	72"	27.10	25.20	23.30	21.70
MC9333-XX	ANY	PRICE UPON REQUEST			

RG316-DS COAX, DOUBLE SHIELDED

<u>MODEL#</u>	<u>LENGTH</u>	<u>1-24</u>	<u>25-49</u>	<u>50-99</u>	<u>100+</u>
MC9336-12	12"	24.20	22.50	20.80	19.35
MC9336-24	24"	26.20	24.35	22.55	20.95
MC9336-36	36"	28.20	26.25	24.25	22.55
MC9336-48	48"	30.20	28.10	25.95	24.15
MC9336-60	60"	32.20	29.95	27.70	25.75
MC9336-72	72"	34.20	31.80	29.40	27.35
MC9336-XX	ANY	PRICE UPON REQUEST			

TIMES LMR-100A

<u>MODEL#</u>	<u>LENGTH</u>	<u>1-24</u>	<u>25-49</u>	<u>50-99</u>	<u>100+</u>
MC9421-12	12"	22.00	20.45	18.90	17.60
MC9421-24	24"	22.80	21.20	19.60	18.25
MC9421-36	36"	23.60	21.95	20.30	18.90
MC9421-48	48"	24.40	22.70	21.00	19.50
MC9421-60	60"	25.20	23.45	21.65	20.15
MC9421-72	72"	26.00	24.20	22.35	20.80
MC9421-XX	ANY	PRICE UPON REQUEST			

SMC PLUG TO SMC PLUG RIGHT-ANGLE



RG174A/U COAX

<u>MODEL#</u>	<u>LENGTH</u>	<u>1-24</u>	<u>25-49</u>	<u>50-99</u>	<u>100+</u>
MC9337-12	12"	29.70	27.60	25.55	23.75
MC9337-24	24"	29.90	27.85	25.75	23.95
MC9337-36	36"	30.15	28.05	25.90	24.10
MC9337-48	48"	30.35	28.25	26.10	24.30
MC9337-60	60"	30.60	28.45	26.30	24.45
MC9337-72	72"	30.80	28.65	26.50	24.65
MC9337-XX	ANY	PRICE UPON REQUEST			

RG316/U COAX

<u>MODEL#</u>	<u>LENGTH</u>	<u>1-24</u>	<u>25-49</u>	<u>50-99</u>	<u>100+</u>
MC9340-12	12"	27.50	25.60	23.65	22.00
MC9340-24	24"	28.30	26.30	24.35	22.65
MC9340-36	36"	29.10	27.05	25.05	23.30
MC9340-48	48"	29.90	27.80	25.70	23.90
MC9340-60	60"	30.70	28.55	26.40	24.55
MC9340-72	72"	31.50	29.30	27.10	25.20
MC9340-XX	ANY	PRICE UPON REQUEST			

RG178B/U COAX

<u>MODEL#</u>	<u>LENGTH</u>	<u>1-24</u>	<u>25-49</u>	<u>50-99</u>	<u>100+</u>
MC9338-12	12"	28.60	26.60	24.60	22.90
MC9338-24	24"	29.40	27.35	25.30	23.50
MC9338-36	36"	30.20	28.10	25.95	24.15
MC9338-48	48"	31.00	28.85	26.65	24.80
MC9338-60	60"	31.80	29.55	27.35	25.45
MC9338-72	72"	32.60	30.30	28.05	26.10
MC9338-XX	ANY	PRICE UPON REQUEST			

RG316-DS COAX, DOUBLE SHIELDED

<u>MODEL#</u>	<u>LENGTH</u>	<u>1-24</u>	<u>25-49</u>	<u>50-99</u>	<u>100+</u>
MC9341-12	12"	29.70	27.60	25.55	23.75
MC9341-24	24"	31.70	29.50	27.25	25.35
MC9341-36	36"	33.70	31.35	29.00	26.95
MC9341-48	48"	35.70	33.20	30.70	28.55
MC9341-60	60"	37.70	35.05	32.40	30.15
MC9341-72	72"	39.70	36.90	34.15	31.75
MC9341-XX	ANY	PRICE UPON REQUEST			

TIMES LMR-100A

<u>MODEL#</u>	<u>LENGTH</u>	<u>1-24</u>	<u>25-49</u>	<u>50-99</u>	<u>100+</u>
MC9422-12	12"	27.50	25.60	23.65	22.00
MC9422-24	24"	28.30	26.30	24.35	22.65
MC9422-36	36"	29.10	27.05	25.05	23.30
MC9422-48	48"	29.90	27.80	25.70	23.90
MC9422-60	60"	30.70	28.55	26.40	24.55
MC9422-72	72"	31.30	29.30	27.10	25.20
MC9422-XX	ANY	PRICE UPON REQUEST			



RG174A/U COAX

<u>MODEL#</u>	<u>LENGTH</u>	<u>1-24</u>	<u>25-49</u>	<u>50-99</u>	<u>100+</u>
MC9342-12	12"	29.70	27.60	25.55	23.75
MC9342-24	24"	29.90	27.85	25.75	23.95
MC9342-36	36"	30.15	28.05	25.90	24.10
MC9342-48	48"	30.35	28.25	26.10	24.30
MC9342-60	60"	30.60	28.45	26.30	24.45
MC9342-72	72"	30.80	28.65	26.50	24.65
MC9342-XX	ANY	PRICE UPON REQUEST			

RG316/U COAX

<u>MODEL#</u>	<u>LENGTH</u>	<u>1-24</u>	<u>25-49</u>	<u>50-99</u>	<u>100+</u>
MC9345-12	12"	29.70	27.60	25.55	23.75
MC9345-24	24"	30.50	28.35	26.25	24.40
MC9345-36	36"	31.30	29.10	26.90	25.05
MC9345-48	48"	32.10	29.85	27.60	25.70
MC9345-60	60"	32.90	30.60	28.30	26.30
MC9345-72	72"	33.70	31.35	29.00	26.95
MC9345-XX	ANY	PRICE UPON REQUEST			

RG178B/U COAX

<u>MODEL#</u>	<u>LENGTH</u>	<u>1-24</u>	<u>25-49</u>	<u>50-99</u>	<u>100+</u>
MC9343-12	12"	30.80	28.65	26.50	24.65
MC9343-24	24"	31.60	29.40	27.20	25.30
MC9343-36	36"	32.40	30.15	27.85	25.90
MC9343-48	48"	33.20	30.90	28.55	26.65
MC9343-60	60"	34.00	31.60	29.25	27.20
MC9343-72	72"	34.80	32.35	29.95	27.85
MC9343-XX	ANY	PRICE UPON REQUEST			

RG316-DS COAX, DOUBLE SHIELDED

<u>MODEL#</u>	<u>LENGTH</u>	<u>1-24</u>	<u>25-49</u>	<u>50-99</u>	<u>100+</u>
MC9346-12	12"	31.90	29.65	27.45	25.50
MC9346-24	24"	33.90	31.55	29.15	27.10
MC9346-36	36"	35.90	33.40	30.85	28.70
MC9346-48	48"	37.90	35.25	32.60	30.30
MC9346-60	60"	39.90	37.10	34.30	31.90
MC9346-72	72"	41.90	38.95	36.05	33.50
MC9346-XX	ANY	PRICE UPON REQUEST			

TIMES LMR-100A

<u>MODEL#</u>	<u>LENGTH</u>	<u>1-24</u>	<u>25-49</u>	<u>50-99</u>	<u>100+</u>
MC9423-12	12"	29.70	27.60	25.55	23.75
MC9423-24	24"	30.50	28.35	26.25	24.40
MC9423-36	36"	31.30	29.10	26.90	25.05
MC9423-48	48"	32.10	29.85	27.60	25.70
MC9423-60	60"	32.90	30.60	28.30	26.30
MC9423-72	72"	33.70	31.35	29.00	26.95
MC9423-XX	ANY	PRICE UPON REQUEST			

SMC PLUG RIGHT-ANGLE TO SMC JACK BULKHEAD



RG174A/U COAX

<u>MODEL#</u>	<u>LENGTH</u>	<u>1-24</u>	<u>25-49</u>	<u>50-99</u>	<u>100+</u>
MC9347-12	12"	29.70	27.60	25.55	23.75
MC9347-24	24"	29.90	27.85	25.75	23.95
MC9347-36	36"	30.15	28.05	25.90	24.10
MC9347-48	48"	30.35	28.25	26.10	24.30
MC9347-60	60"	30.60	28.45	26.30	24.45
MC9347-72	72"	30.80	28.65	26.50	24.65
MC9347-XX	ANY	PRICE UPON REQUEST			

RG316/U COAX

<u>MODEL#</u>	<u>LENGTH</u>	<u>1-24</u>	<u>25-49</u>	<u>50-99</u>	<u>100+</u>
MC9350-12	12"	29.70	27.60	25.55	23.75
MC9350-24	24"	30.50	28.35	26.25	24.40
MC9350-36	36"	31.30	29.10	26.90	25.05
MC9350-48	48"	32.10	29.85	27.60	25.70
MC9350-60	60"	32.90	30.60	28.30	26.30
MC9350-72	72"	33.70	31.35	29.00	26.95
MC9350-XX	ANY	PRICE UPON REQUEST			

RG178B/U COAX

<u>MODEL#</u>	<u>LENGTH</u>	<u>1-24</u>	<u>25-49</u>	<u>50-99</u>	<u>100+</u>
MC9348-12	12"	33.00	30.70	28.40	26.40
MC9348-24	24"	33.80	31.45	29.05	27.05
MC9348-36	36"	34.60	32.20	29.75	27.70
MC9348-48	48"	35.40	32.90	30.45	28.30
MC9348-60	60"	36.20	33.65	31.15	28.95
MC9348-72	72"	37.00	34.40	31.80	29.60
MC9348-XX	ANY	PRICE UPON REQUEST			

RG316-DS COAX, DOUBLE SHIELDED

<u>MODEL#</u>	<u>LENGTH</u>	<u>1-24</u>	<u>25-49</u>	<u>50-99</u>	<u>100+</u>
MC9351-12	12"	31.90	29.65	27.45	25.50
MC9351-24	24"	33.90	31.55	29.15	27.10
MC9351-36	36"	35.90	33.40	30.85	28.70
MC9351-48	48"	37.90	35.25	32.60	30.30
MC9351-60	60"	39.90	37.10	34.30	31.90
MC9351-72	72"	41.90	38.95	36.05	33.50
MC9351-XX	ANY	PRICE UPON REQUEST			

TIMES LMR-100A

<u>MODEL#</u>	<u>LENGTH</u>	<u>1-24</u>	<u>25-49</u>	<u>50-99</u>	<u>100+</u>
MC9424-12	12"	29.70	27.60	25.55	23.75
MC9424-24	24"	30.50	28.35	26.25	24.40
MC9424-36	36"	31.30	29.10	26.90	25.05
MC9424-48	48"	32.10	29.85	27.60	25.70
MC9424-60	60"	32.90	30.60	28.30	26.30
MC9424-72	72"	33.70	31.35	29.00	26.95
MC9424-XX	ANY	PRICE UPON REQUEST			

SMC PLUG TO SMC JACK BULKHEAD



RG174A/U COAX

<u>MODEL#</u>	<u>LENGTH</u>	<u>1-24</u>	<u>25-49</u>	<u>50-99</u>	<u>100+</u>
MC9352-12	12"	29.70	27.60	25.55	23.75
MC9352-24	24"	29.90	27.85	25.75	23.95
MC9352-36	36"	30.15	28.05	25.90	24.10
MC9352-48	48"	30.35	28.25	26.10	24.30
MC9352-60	60"	30.60	28.45	26.30	24.45
MC9352-72	72"	30.80	28.65	26.50	24.65
MC9352-XX	ANY	PRICE UPON REQUEST			

RG316/U COAX

<u>MODEL#</u>	<u>LENGTH</u>	<u>1-24</u>	<u>25-49</u>	<u>50-99</u>	<u>100+</u>
MC9355-12	12"	27.50	25.60	23.65	22.00
MC9355-24	24"	28.30	26.30	24.35	22.65
MC9355-36	36"	29.10	27.05	25.05	23.30
MC9355-48	48"	29.90	27.80	25.70	23.90
MC9355-60	60"	30.70	28.55	26.40	24.55
MC9355-72	72"	31.50	29.30	27.10	25.20
MC9355-XX	ANY	PRICE UPON REQUEST			

RG178B/U COAX

<u>MODEL#</u>	<u>LENGTH</u>	<u>1-24</u>	<u>25-49</u>	<u>50-99</u>	<u>100+</u>
MC9353-12	12"	30.80	28.65	26.50	24.65
MC9353-24	24"	31.60	29.40	27.20	25.30
MC9353-36	36"	32.40	30.15	27.85	25.90
MC9353-48	48"	33.20	30.90	28.55	26.65
MC9353-60	60"	34.00	31.60	29.25	27.20
MC9353-72	72"	34.80	32.35	29.95	27.85
MC9353-XX	ANY	PRICE UPON REQUEST			

RG316-DS COAX, DOUBLE SHIELDED

<u>MODEL#</u>	<u>LENGTH</u>	<u>1-24</u>	<u>25-49</u>	<u>50-99</u>	<u>100+</u>
MC9356-12	12"	29.70	27.60	25.55	23.75
MC9356-24	24"	31.70	29.50	27.25	25.35
MC9356-36	36"	33.70	31.35	29.00	26.95
MC9356-48	48"	35.70	33.20	30.70	28.55
MC9356-60	60"	37.70	35.05	32.40	30.15
MC9356-72	72"	39.70	36.90	34.15	31.75
MC9356-XX	ANY	PRICE UPON REQUEST			

TIMES LMR-100A

<u>MODEL#</u>	<u>LENGTH</u>	<u>1-24</u>	<u>25-49</u>	<u>50-99</u>	<u>100+</u>
MC9425-12	12"	27.50	25.60	23.65	22.00
MC9425-24	24"	28.30	26.30	24.35	22.65
MC9425-36	36"	29.10	27.05	25.05	23.30
MC9425-48	48"	29.90	27.80	25.70	23.90
MC9425-60	60"	30.70	28.55	26.40	24.55
MC9425-72	72"	31.30	29.30	27.10	25.20
MC9425-XX	ANY	PRICE UPON REQUEST			

SMA MALE TO SMC PLUG



RG174A/U COAX

<u>MODEL#</u>	<u>LENGTH</u>	<u>1-24</u>	<u>25-49</u>	<u>50-99</u>	<u>100+</u>
MC9357-6	6"	29.70	27.60	25.55	23.75
MC9357-12	12"	29.80	27.70	25.65	23.85
MC9357-18	18"	29.90	27.85	25.75	23.95
MC9357-24	24"	30.05	27.95	25.85	24.00
MC9357-36	36"	30.25	28.15	26.00	24.20
MC9357-48	48"	30.45	28.35	26.20	24.40
MC9357-60	60"	30.70	28.55	26.40	24.55
MC9357-72	72"	30.90	28.75	26.60	24.75
MC9357-XX	ANY	PRICE UPON REQUEST			

RG316/U COAX

<u>MODEL#</u>	<u>LENGTH</u>	<u>1-24</u>	<u>25-49</u>	<u>50-99</u>	<u>100+</u>
MC9360-6	6"	29.70	27.60	25.55	23.75
MC9360-12	12"	30.10	28.00	25.90	24.10
MC9360-18	18"	30.50	28.35	26.25	24.40
MC9360-24	24"	30.90	28.75	26.55	24.70
MC9360-36	36"	31.70	29.50	27.25	25.35
MC9360-48	48"	32.50	30.25	27.95	26.00
MC9360-60	60"	33.30	30.95	28.65	26.65
MC9360-72	72"	34.10	31.70	29.35	27.30
MC9360-XX	ANY	PRICE UPON REQUEST			

RG178B/U COAX

<u>MODEL#</u>	<u>LENGTH</u>	<u>1-24</u>	<u>25-49</u>	<u>50-99</u>	<u>100+</u>
MC9358-6	6"	41.80	38.85	35.95	33.45
MC9358-12	12"	42.20	39.25	36.30	33.75
MC9358-18	18"	42.60	39.60	36.65	34.10
MC9358-24	24"	43.00	40.00	37.00	34.40
MC9358-36	36"	43.80	40.75	37.65	35.05
MC9358-48	48"	44.60	41.50	38.35	35.70
MC9358-60	60"	45.40	42.20	39.05	36.30
MC9358-72	72"	46.20	42.95	39.75	36.95
MC9358-XX	ANY	PRICE UPON REQUEST			

RG316-DS COAX, DOUBLE SHIELDED

<u>MODEL#</u>	<u>LENGTH</u>	<u>1-24</u>	<u>25-49</u>	<u>50-99</u>	<u>100+</u>
MC9361-6	6"	31.90	29.65	27.45	25.50
MC9361-12	12"	32.90	30.60	28.30	26.30
MC9361-18	18"	33.90	31.55	29.15	27.10
MC9361-24	24"	34.90	32.45	30.00	27.90
MC9361-36	36"	36.90	34.30	31.75	29.50
MC9361-48	48"	38.90	36.20	33.45	31.10
MC9361-60	60"	40.90	38.05	35.15	32.70
MC9361-72	72"	42.90	39.90	36.90	34.30
MC9361-XX	ANY	PRICE UPON REQUEST			

TIMES LMR-100A

<u>MODEL#</u>	<u>LENGTH</u>	<u>1-24</u>	<u>25-49</u>	<u>50-99</u>	<u>100+</u>
MC9426-12	12"	29.70	27.60	25.55	23.75
MC9426-24	24"	30.50	28.35	26.25	24.40
MC9426-36	36"	31.30	29.10	26.90	25.05
MC9426-48	48"	32.10	29.85	27.60	25.70
MC9426-60	60"	32.90	30.60	28.30	26.30
MC9426-72	72"	33.70	31.35	29.00	26.95
MC9426-XX	ANY	PRICE UPON REQUEST			

BNC MALE TO TNC MALE



RG58C/U COAX

<u>MODEL#</u>	<u>LENGTH</u>	<u>1-24</u>	<u>25-49</u>	<u>50-99</u>	<u>100+</u>
MC9371-12	12"	18.70	17.40	16.10	14.95
MC9371-24	24"	19.05	17.70	16.35	15.25
MC9371-36	36"	19.40	18.00	16.65	15.50
MC9371-48	48"	19.70	18.35	16.95	15.80
MC9371-60	60"	20.05	18.65	17.25	16.05
MC9371-72	72"	20.40	18.95	17.55	16.30
MC9371-XX	ANY	PRICE UPON REQUEST			

RG223/U COAX, DOUBLE SHIELDED

<u>MODEL#</u>	<u>LENGTH</u>	<u>1-24</u>	<u>25-49</u>	<u>50-99</u>	<u>100+</u>
MC9374-12	12"	23.38	21.75	20.13	18.69
MC9374-24	24"	24.75	23.00	21.31	19.81
MC9374-36	36"	26.13	24.31	22.44	20.88
MC9374-48	48"	27.50	25.56	23.63	22.00
MC9374-60	60"	28.88	26.88	24.81	23.13
MC9374-72	72"	30.25	28.13	26.00	24.19
MC9374-XX	ANY	PRICE UPON REQUEST			

RG142B/U COAX, DOUBLE SHIELDED

<u>MODEL#</u>	<u>LENGTH</u>	<u>1-24</u>	<u>25-49</u>	<u>50-99</u>	<u>100+</u>
MC9372-12	12"	23.38	21.75	20.13	18.69
MC9372-24	24"	26.13	24.31	22.44	20.88
MC9372-36	36"	28.88	26.88	24.81	23.13
MC9372-48	48"	31.63	29.44	27.19	25.31
MC9372-60	60"	34.38	32.00	29.56	27.50
MC9372-72	72"	37.13	34.50	31.94	29.69
MC9372-XX	ANY	PRICE UPON REQUEST			

RG316/U COAX

<u>MODEL#</u>	<u>LENGTH</u>	<u>1-24</u>	<u>25-49</u>	<u>50-99</u>	<u>100+</u>
MC9375-12	12"	23.10	21.50	19.85	18.50
MC9375-24	24"	23.90	22.25	20.55	19.10
MC9375-36	36"	24.70	22.95	21.25	19.75
MC9375-48	48"	25.50	23.70	21.95	20.40
MC9375-60	60"	26.30	24.45	22.60	21.05
MC9375-72	72"	27.10	25.20	23.30	21.70
MC9375-XX	ANY	PRICE UPON REQUEST			

RG174A/U COAX

<u>MODEL#</u>	<u>LENGTH</u>	<u>1-24</u>	<u>25-49</u>	<u>50-99</u>	<u>100+</u>
MC9373-12	12"	18.70	17.40	16.10	14.95
MC9373-24	24"	18.90	17.60	16.25	15.15
MC9373-36	36"	19.15	17.80	16.45	15.30
MC9373-48	48"	19.35	18.00	16.65	15.50
MC9373-60	60"	19.60	18.20	16.85	15.65
MC9373-72	72"	19.80	18.40	17.05	15.85
MC9373-XX	ANY	PRICE UPON REQUEST			

RG400/U COAX, DOUBLE SHIELDED

<u>MODEL#</u>	<u>LENGTH</u>	<u>1-24</u>	<u>25-49</u>	<u>50-99</u>	<u>100+</u>
MC9376-12	12"	18.70	17.40	16.10	14.95
MC9376-24	24"	20.90	19.45	17.95	16.70
MC9376-36	36"	23.10	21.50	19.85	18.50
MC9376-48	48"	25.30	23.55	21.75	20.25
MC9376-60	60"	27.50	25.60	23.65	22.00
MC9376-72	72"	29.70	27.60	25.55	23.75
MC9376-XX	ANY	PRICE UPON REQUEST			

TIMES LMR-195



<u>MODEL#</u>	<u>LENGTH</u>	<u>1-24</u>	<u>25-49</u>	<u>50-99</u>	<u>100+</u>
MC9427-12	12"	18.70	17.40	16.10	14.95
MC9427-24	24"	19.40	18.10	16.80	15.65
MC9427-36	36"	20.10	18.80	17.50	16.35
MC9427-48	48"	20.80	19.50	18.20	17.05
MC9427-60	60"	21.50	20.20	18.90	17.75
MC9427-72	72"	22.20	20.90	19.60	18.45
MC9427-XX	ANY	PRICE UPON REQUEST			

TIMES LMR-240

<u>MODEL#</u>	<u>LENGTH</u>	<u>1-24</u>	<u>25-49</u>	<u>50-99</u>	<u>100+</u>
MC9428-12	12"	18.70	17.40	16.10	14.95
MC9428-24	24"	19.40	18.10	16.80	15.65
MC9428-36	36"	20.10	18.80	17.50	16.35
MC9428-48	48"	20.80	19.50	18.20	17.05
MC9428-60	60"	21.50	20.20	18.90	17.75
MC9428-72	72"	22.20	20.90	19.60	18.45
MC9428-XX	ANY	PRICE UPON REQUEST			

MMCX PLUG TO MMCX PLUG

**MMCX PLUG TO MMCX
PLUG RIGHT-ANGLE**

											
RG174A/U COAX						RG174A/U COAX					
<u>MODEL#</u>	<u>LENGTH</u>	<u>1-24</u>	<u>25-49</u>	<u>50-99</u>	<u>100+</u>	<u>MODEL#</u>	<u>LENGTH</u>	<u>1-24</u>	<u>25-49</u>	<u>50-99</u>	<u>100+</u>
MC9377-12	12"	22.00	20.45	18.90	17.60	MC9383-12	12"	28.00	26.05	24.10	22.40
MC9377-24	24"	22.20	20.65	19.10	17.80	MC9383-24	24"	28.20	26.25	24.25	22.60
MC9377-36	36"	22.45	20.85	19.30	17.95	MC9383-36	36"	28.45	26.45	24.45	22.75
MC9377-48	48"	22.65	21.05	19.50	18.15	MC9383-48	48"	28.65	26.65	24.65	22.95
MC9377-60	60"	22.90	21.30	19.70	18.30	MC9383-60	60"	28.90	26.85	24.85	23.10
MC9377-72	72"	23.10	21.50	19.85	18.50	MC9383-72	72"	29.10	27.05	25.05	23.30
MC9377-XX	ANY	PRICE UPON REQUEST				MC9383-XX	ANY	PRICE UPON REQUEST			
RG178B/U COAX						RG178B/U COAX					
<u>MODEL#</u>	<u>LENGTH</u>	<u>1-24</u>	<u>25-49</u>	<u>50-99</u>	<u>100+</u>	<u>MODEL#</u>	<u>LENGTH</u>	<u>1-24</u>	<u>25-49</u>	<u>50-99</u>	<u>100+</u>
MC9378-12	12"	23.00	21.40	19.80	18.40	MC9384-12	12"	29.00	26.95	24.95	23.20
MC9378-24	24"	23.80	22.15	20.45	19.05	MC9384-24	24"	29.80	27.70	25.65	23.85
MC9378-36	36"	24.60	22.90	21.15	19.70	MC9384-36	36"	30.60	28.45	26.30	24.50
MC9378-48	48"	25.40	23.60	21.85	20.30	MC9384-48	48"	31.40	29.20	27.00	25.10
MC9378-60	60"	26.20	24.35	22.55	20.95	MC9384-60	60"	32.20	29.95	27.70	25.75
MC9378-72	72"	27.00	25.10	23.20	21.60	MC9384-72	72"	33.00	30.70	28.40	26.40
MC9378-XX	ANY	PRICE UPON REQUEST				MC9384-XX	ANY	PRICE UPON REQUEST			
RG316/U COAX						RG316/U COAX					
<u>MODEL#</u>	<u>LENGTH</u>	<u>1-24</u>	<u>25-49</u>	<u>50-99</u>	<u>100+</u>	<u>MODEL#</u>	<u>LENGTH</u>	<u>1-24</u>	<u>25-49</u>	<u>50-99</u>	<u>100+</u>
MC9380-12	12"	22.00	20.45	18.90	17.60	MC9386-12	12"	28.00	26.05	24.10	22.40
MC9380-24	24"	22.80	21.20	19.60	18.25	MC9386-24	24"	28.80	26.80	24.75	23.05
MC9380-36	36"	23.60	21.95	20.30	18.90	MC9386-36	36"	29.60	27.55	25.45	23.70
MC9380-48	48"	24.40	22.70	21.00	19.50	MC9386-48	48"	30.40	28.25	26.15	24.30
MC9380-60	60"	25.20	23.45	21.65	20.15	MC9386-60	60"	31.20	29.00	26.85	24.95
MC9380-72	72"	26.00	24.20	22.35	20.80	MC9386-72	72"	32.00	29.75	26.50	25.60
MC9380-XX	ANY	PRICE UPON REQUEST				MC9386-XX	ANY	PRICE UPON REQUEST			
TIMES LMR-100A						TIMES LMR-100A					
<u>MODEL#</u>	<u>LENGTH</u>	<u>1-24</u>	<u>25-49</u>	<u>50-99</u>	<u>100+</u>	<u>MODEL#</u>	<u>LENGTH</u>	<u>1-24</u>	<u>25-49</u>	<u>50-99</u>	<u>100+</u>
MC9429-12	12"	22.00	20.45	18.90	17.60	MC9430-12	12"	28.00	26.05	24.10	22.40
MC9429-24	24"	22.80	21.20	19.60	18.25	MC9430-24	24"	28.70	26.75	24.80	23.10
MC9429-36	36"	23.60	21.95	20.30	18.90	MC9430-36	36"	29.40	27.45	25.50	23.80
MC9429-48	48"	24.40	22.70	21.00	19.50	MC9430-48	48"	30.10	28.15	26.20	24.50
MC9429-60	60"	25.20	23.45	21.65	20.15	MC9430-60	60"	30.80	28.85	26.90	25.20
MC9429-72	72"	26.00	24.20	22.35	20.80	MC9430-72	72"	31.50	29.55	27.60	25.90
MC9429-XX	ANY	PRICE UPON REQUEST				MC9430-XX	ANY	PRICE UPON REQUEST			

MMCX PLUG TO SMA MALE



RG174A/U COAX

<u>MODEL#</u>	<u>LENGTH</u>	<u>1-24</u>	<u>25-49</u>	<u>50-99</u>	<u>100+</u>
MC9381-12	12"	28.00	26.05	24.10	22.40
MC9381-24	24"	28.20	26.25	24.25	22.60
MC9381-36	36"	28.45	26.45	24.45	22.75
MC9381-48	48"	28.65	26.65	24.65	22.95
MC9381-60	60"	28.90	26.85	24.85	23.10
MC9381-72	72"	29.10	27.05	25.05	23.30
MC9381-XX	ANY	PRICE UPON REQUEST			

RG316/U COAX

<u>MODEL#</u>	<u>LENGTH</u>	<u>1-24</u>	<u>25-49</u>	<u>50-99</u>	<u>100+</u>
MC9387-12	12"	28.00	26.05	24.10	22.40
MC9387-24	24"	28.80	26.80	24.75	23.05
MC9387-36	36"	29.60	27.55	25.45	23.70
MC9387-48	48"	30.40	28.25	26.15	24.30
MC9387-60	60"	31.20	29.00	26.85	24.95
MC9387-72	72"	32.00	29.75	27.50	25.60
MC9387-XX	ANY	PRICE UPON REQUEST			

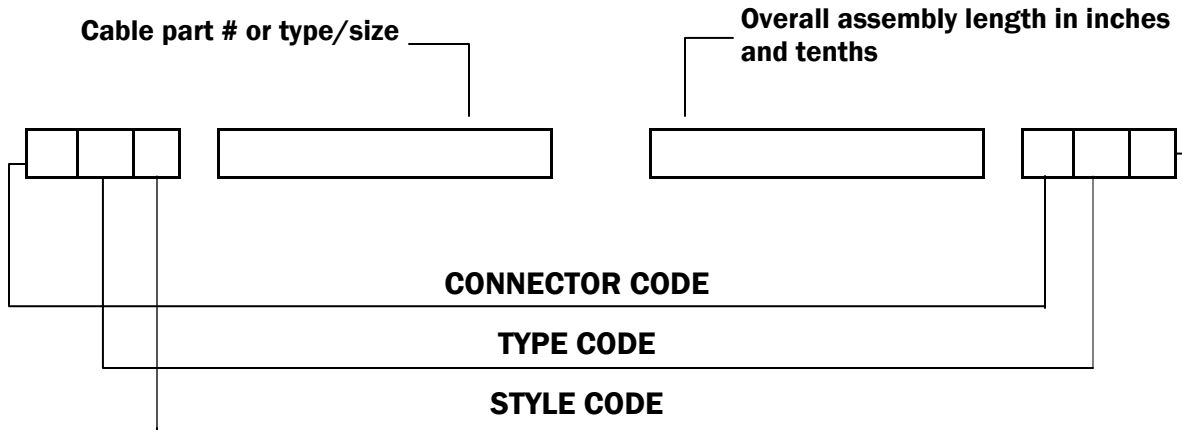
RG178B/U COAX

<u>MODEL#</u>	<u>LENGTH</u>	<u>1-24</u>	<u>25-49</u>	<u>50-99</u>	<u>100+</u>
MC9382-12	12"	29.00	26.95	24.95	23.20
MC9382-24	24"	29.80	27.70	25.65	23.85
MC9382-36	36"	30.60	28.45	26.30	24.50
MC9382-48	48"	31.40	29.20	27.00	25.10
MC9382-60	60"	32.20	29.95	27.70	25.75
MC9382-72	72"	33.00	30.70	28.40	26.40
MC9382-XX	ANY	PRICE UPON REQUEST			

TIMES LMR-100A

<u>MODEL#</u>	<u>LENGTH</u>	<u>1-24</u>	<u>25-49</u>	<u>50-99</u>	<u>100+</u>
MC9431-12	12"	28.00	26.05	24.10	22.40
MC9431-24	24"	28.70	26.75	24.80	23.10
MC9431-36	36"	29.40	27.45	25.50	23.80
MC9431-48	48"	30.10	28.15	26.20	24.50
MC9431-60	60"	30.80	28.85	26.90	25.20
MC9431-72	72"	31.50	29.55	27.60	25.90
MC9431-XX	ANY	PRICE UPON REQUEST			

CUSTOM CABLE ASSEMBLY BY DESCRIPTION



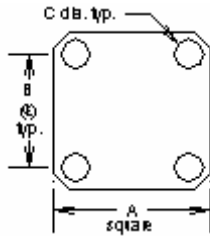
CONNECT OF CODE
BNC-A
N-B
BMA-C
SMA-D
SMB-E
SMC-F
TNC-G
MCX-H
MMCX-J
F-K
L-SSMB
M-SSMC

TYPE CODE
MALE—M
FEMALE—F
FEMALE BULKHEAD— BF

STYLE CODE
STRAIGHT—S
RIGHT ANGLE—R

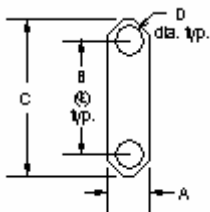
Example:
AMS-RG142-40.0-DMR
BNC MALE STRAIGHT-RG142-40 INCH—
SMA MALE RIGHT ANGLE

CONNECTOR FLANGES
(Panel mounted connectors)



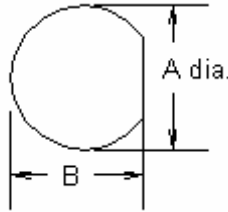
4-hole flanges			
Figure	A	B	C
04	1/2	.360	.089
05	1/2	.340	.102
07	11/16	.500	#3-56 tap
09	11/16	.500	.136
10	11/16	.500	.120
12	11/16	.500	.109
18	3/4	.531	.136
26	1	.718	#6-32 tap
27	1	.718	#4-40 tap
30	1	.718	.166
32	1	.718	.136
32A	1	.718	.136*
33	1	.718	.125
34	1 3/32	.812	.150
36	1 3/16	.906	#6-32 tap
39	1 3/16	.906	.152
40	1 3/16	.906	.125
45	2	1.437	.257
91	.375	.250	.067
91A	.375	.232	.093

*Countersunk to .245 dia.

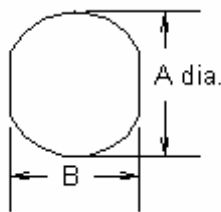


2-hole flanges				
Figure	A	B	C	D
92	.223	.481	.625	.102
92A	.260	.481	.625	.102
95	.640	1.015	1.30	.125
96	.187	.328	.480	.093

PANEL CUTOUTS
(Bulkhead mounted connectors)

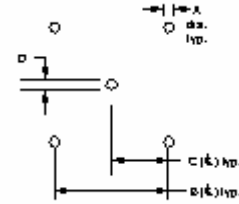


D-Hole		
Figure	A	B
51	.755	.723
54	.630	.598
55	.630	.583
57	.557	.531
59	.505	.473
62	.442	.410
63	.407	.362
65	.380	.348
66	.319	.292
67	.255	.236
68	.195	.176
97	.330	.297
98	.140	.126



Double D-Hole		
Figure	A	B
69	.755	.692
72	.630	.536
75	.380	.341
84	.319	.278

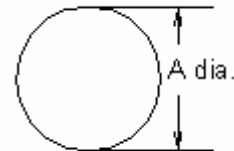
P.C. BOARD DRILLING



(PCB traces are shown for illustrative purpose only, and are not representative of actual circuitry.)

Coaxial Connectors

Figure	A	B	C	D
PCB01	.067	.400	.200	.045
PCB02	.045	.500	.250	.045
PCB03	.067	.300	.150	.035
PCB05	.067	.300	.150	.055
PCB06	.067	.200	.100	.045
PCB07	.045	.177	.088	.045
PCB08	.032	.100	.050	.032
PCB09	.038	.100	.050	.036



Round Hole	
Figure	A
82	.255
89	.380

INDEX

MC1001	47	MC1102	58	MC1180	46	MC1232	45
MC1002	48	MC1103	58	MC1181	46	MC1233	45
MC1003	47	MC1104	58	MC1182	46	MC1234	45
MC1004	48	MC1109	58	MC1183	47	MC1235	45
MC1005	47	MC1110	58	MC1184	47	MC1237	44
MC1006	48	MC1111	58	MC1186	47	MC1238	44
MC1007	47	MC1112	58	MC1187	47	MC1239	36
MC1008	48	MC1113	58	MC1188	39	MC1240	36
MC1009	42	MC1114	58	MC1189	39	MC1241	36
MC1010	41	MC1115	58	MC1190	39	MC1242	36
MC1011	41	MC1116	58	MC1191	40	MC1243	49
MC1012	42	MC1117	57	MC1192	40	MC1244	49
MC1013	40	MC1118	57	MC1193	40	MC1245	49
MC1014	44	MC1119	57	MC1194	40	MC1246	40
MC1015	44	MC1120	57	MC1195	37	MC1247	49
MC1016	43	MC1121	57	MC1196	37	MC1248	49
MC1017	43	MC1122	57	MC1197	37	MC1249	44
MC1018	45	MC1123	57	MC1198	37	MC1250	50
MC1019	42	MC1124	57	MC1199	37	MC1251	50
MC1020	42	MC1125	57	MC1200	37	MC1252	50
MC1021	45	MC1126	57	MC1201	37	MC1253	50
MC1022	46	MC1127	57	MC1202	37	MC1254	50
MC1023	42	MC1128	57	MC1203	38	MC1255	50
MC1025	48	MC1129	57	MC1204	38	MC1256	50
MC1026	49	MC1130	57	MC1205	38	MC1257	50
MC1027	48	MC1131	57	MC1206	38	MC1258	50
MC1028	49	MC1132	57	MC1207	38	MC1259	50
MC1030	48	MC1133	57	MC1208	38	MC1260	50
MC1031	49	MC1134	57	MC1209	38	MC1261	50
MC1032	48	MC1135	57	MC1210	38	MC1262	50
MC1033	49	MC1136	57	MC1211	39	MC1263	50
MC1035	41	MC1137	57	MC1212	39	MC1264	50
MC1036	41	MC1138	57	MC1213	39	MC1265	50
MC1037	41	MC1139	57	MC1214	39	MC1266	50
MC1038	42	MC1140	57	MC1215	39	MC1267	50
MC1039	41	MC1141	57	MC1216	40	MC1268	50
MC1040	45	MC1142	57	MC1218	40	MC1269	51
MC1041	43	MC1143	57	MC1219	41	MC1270	51
MC1042	46	MC1144	57	MC1220	41	MC1271	51
MC1043	43	MC1145	57	MC1222	42	MC1272	51
MC1090	58	MC1146	57	MC1223	42	MC1273	50
MC1095	58	MC1147	57	MC1224	43	MC1274	50
MC1096	58	MC1148	57	MC1225	43	MC1275	50
MC1097	58	MC1153	44	MC1227	43	MC1276	50
MC1098	58	MC1154	58	MC1228	43	MC1277	51
MC1099	58	MC1177	46	MC1229	44	MC1278	51
MC1100	58	MC1178	46	MC1230	44	MC1279	51
MC1101	58	MC1179	46	MC1231	45	MC1280	51

INDEX

MC1281	51	MC2010	3	MC2113	3	MC2163	7
MC1282	51	MC2011	3	MC2114	3	MC2164	7
MC1283	51	MC2012	3	MC2115	3	MC2165	7
MC1284	51	MC2013	4	MC2116	3	MC2166	7
MC1265	52	MC2014	4	MC2117	3	MC2167	7
MC1286	52	MC2015	4	MC2118	3	MC2168	7
MC1287	52	MC2016	4	MC2119	3	MC2169	7
MC1288	52	MC2017	4	MC2120	4	MC2170	7
MC1289	52	MC2024	4	MC2121	4	MC2171	7
MC1290	52	MC2027	4	MC2122	5	MC2172	7
MC1291	52	MC2028	4	MC2123	5	MC2173	8
MC1292	52	MC2029	4	MC2124	5	MC2174	8
MC1293	52	MC2030	4	MC2125	5	MC2175	8
MC1294	52	MC2031	4	MC2126	5	MC2176	8
MC1295	52	MC2032	4	MC2127	5	MC2177-4	53
MC1296	52	MC2033	4	M02128	5	MC2177-12	54
MC1297	52	MC2034	4	MC2129	5	MC2177-18	54
MC1298	52	MC2039	4	MC2130	5	MC2178-4	53
MC1299	52	MC2040	4	MC2131	5	MC2176-12	54
MC1300	52	MC2041	5	MC2132	5	MC2178-18	54
MC1301	52	MC2042	5	MC2133	6	MC2179-4	53
MC1302	52	MC2043	5	MC2134	6	MC2179-12	54
MC1303	52	MC2044	5	MC2135	6	MC2179-18	54
MC1304	52	MC2047	5	MC2136	6	MC2180-4	53
MC1307	52	MC2046	6	MC2137	6	MC2180-12	54
MC1308	52	MC2049	6	MC2138	6	MC2180-18	54
MC1309	52	MC2050	6	MC2139	6	MC2181-4	53
MC1310	52	MC2051	6	MC2140	6	MC2181-12	54
MC1311	53	MC2052	6	MC2141	6	MC2181-18	54
MC1312	53	MC2053	29	MC2142	6	MC2182-4	53
MC1313	53	MC2054	28	MC2143	6	MC2182-12	54
MC1314	53	MC2055	29	MC2144	3	MC2182-18	54
MC1315	53	MC2056	29	MC2145	30	MC2183-4	53
MC1316	53	MC2057	29	MC2146	31	MC2183-12	54
MC1317	51	MC2058	29	MC2147	31	MC2183-18	54
MC1320	30	MC2059	30	MC2148	31	MC2184-4	53
MC1321	35	MC2060	30	MC2149	31	MC2184-12	54
MC1322	29	MC2061	30	MC2150	31	MC2184-18	54
MC2000	3	MC2062	30	MC2151	31	MC2185-4	53
MC2001	3	MC2081	3	MC2152	31	MC2185-12	54
MC2002	3	MC2083	30	MC2153	31	MC2185-18	54
MC2003	3	MC2088	3	MC2154	32	MC2186-4	53
MC2004	3	MC2089	3	MC2155	32	MC2186-12	54
MC2005	3	MC2091	3	MC2156	32	MC2186-18	54
MC2006	3	MC2094	4	MC2157	32	MC2187-4	53
MC2007	3	MC2102	29	MC2158	29	MC2187-12	54
MC2008	3	MC2111	3	MC2161	7	MC2187-18	54
MC2009	3	MC2112	3	MC2162	7	MC2188-4	53

INDEX

MC2188-12	54	MC3025	34	MC4022	23	MC5021	12
MC2188-18	54	MC3026	35	MC4023	23	MC5022	12
MC2189-4	53	MC3027	35	MC4024	23	MC5023	9
MC2189-12	54	MC3028	35	MC4025	32	MC5024	9
MC2189-18	54	MC3029	35	MC4026	32	MC5025	12
MC2190-4	53	MC3030	22	MC4027	32	MC5027	9
MC2190-12	54	MC3033	22	M04028	33	MC5028	9
MC2190-18	54	MC3037	22	MC4029	33	MC5029	9
MC2191-4	53	MC3045	22	MC4030	33	MC5030	12
MC2191-12	54	MC3046	22	MC4031	23	MC5031	12
MC2191-18	54	MC3048	35	MC4043	23	MC5032	12
MC2192-4	53	MC3049	35	MC4044	23	MC5033	9
MC2192-12	54	MC3050	36	MC4045	23	MC5034	9
MC2192-18	54	MC3051	36	MC4046	23	MC5035	12
MC2193-4	53	MC3052	36	MC4047	23	MC5036	12
MC2193-12	54	MC3053	35	MC4050	32	MC5037	10
MC2193-18	54	MC3054	55	MC4051	33	MC5038	10
MC2194-4	53	MC3055	55	MC4052	33	MC5039	13
MC2194-12	54	MC3056	55	MC4053	56	MC5040	13
MC2194-18	54	MC3057	55	MC4054	56	MC5041	10
MC2195	55	MC3058	55	MC4055	56	MC5042	10
MC2196	55	MC3059	55	MC4056	56	MC5043	13
MC2197	55	MC3060	55	MC4057	56	MC5044	13
MC2198	55	MC3061	55	MC4058	56	MC5045	10
MC2199	55	MC3062	55	MC4059	56	MC5046	10
MC2200	55	MC3063	55	MC4060	56	MC5047	10
MC2201	55	MC3064	56	MC4061	56	MC5048	13
MC2202	55	MC3065	56	MC4062	56	MC5049	13
MC2203	28	MC3066	56	MC5001	9	MC5050	13
MC3001	22	M03067	56	MC5002	9	MC5051	10
MC3002	22	MC3068	56	MC5003	12	MC5052	10
MC3004	22	MC3069	22	MC5004	12	MC5053	13
MC3005	22	MC4001	23	MC5005	9	MC5055	10
MC3006	22	MC4002	23	MC5006	9	MC5056	13
MC3008	22	MC4003	23	MC5007	12	MC5057	10
MC3009	22	MC4004	23	MC5008	12	MC5058	13
MC3010	22	MC400S	23	MC5009	9	MC5059	10
MC3011	22	MC4006	23	MC5010	9	MC5060	13
MC3012	22	MC4007	23	MC5011	9	MC5061	10
MC3013	22	MC4008	23	MC5012	12	MC5062	13
MC3014	22	MC4011	23	M05013	12	MC5067	11
MC3015	22	MC4012	23	MC5014	12	MC5068	14
MC3016	22	MC4013	23	MC5015	9	MC5069	11
MC3017	22	MC4014	23	MC5016	9	MC5070	14
MC3018	22	MC4015	23	MC5017	12	MC507I	11
MC3021	22	MC4016	23	MC5018	12	MC5072	14
MC3023	22	MC4017	23	MC5019	9	MC5073	11
MC3024	34	MC4021	23	MC5020	9	MC5074	14

INDEX

MC5080	27	MC5149	21	MC5197	27	MC7012	59
MC5081	28	MCS150	21	MC5198	27	MC7013	59
MC5082	27	MC5151	21	MC5199	27	MC7014	59
MC5083	28	MC5152	21	MC5200	27	MC7015	59
MC5084	27	MC5153	21	MC5201	27	MC7016	59
MC5085	28	MC5154	21	MC5202	28	MC7017	59
MC5086	28	MC5155	21	MC5203	30	MC7021	59
MC5087	28	MCS156	21	MC6005	33	MC7022	59
MC5109	9	MC5157	15	MC6006	33	MC7023	59
MC5110	12	MC5158	15	MC6007	33	MC7024	59
MC5111	9	MC5159	15	MC6008	34	MC7115	59
MC5112	12	MC5160	15	MC6009	34	MC7117	59
MC5113	9	MC5161	15	MC6010	34	MC7118	59
MC5114	12	MC5162	15	MC6011	34	MC7119	59
MC5115	9	MC5163	15	MC6012	34	MC7120	59
MC5116	9	MC5164	15	MC6013	34	MC7121	59
MC5117	12	MC516S	15	MC6014	24	MC7122	59
MC5118	12	MC5166	15	MC6015	24	MC7123	59
MC5119	10	MC5167	15	MC6016	24	MC7124	59
MC5120	13	MC5168	15	MC6017	24	MC7125	59
MC5121	10	MC5169	15	MC6018	24	MC7126	59
MC5122	13	MC5170	15	MC6019	24	MC7127	59
MC5123	11	MC5171	15	MC6020	24	MC7128	59
MC5124	20	MC5172	15	MC6021	24	MC7129	59
MC5125	20	MC5173	16	MC6022	24	MC7130	59
MC5126	20	MC5174	16	MC6023	24	MC7131	59
MC5127	20	MCS175	16	MC6024	24	MC7132	59
MC5128	20	MC5176	16	MC6025	24	MC7133	59
MC5129	20	MC5177	17	MC6026	24	MC7134	59
MC5130	20	MC5178	17	MC6027	24	MC7135	59
MC5131	20	MC5179	17	MC6028	24	MC7136	59
MC5132	20	MCS180	17	MC6029	24	MC7137	59
MC5133	20	MCS181	17	MC6030	24	MC7140	59
MC5134	20	MC5182	17	MC6031	24	MC7141	59
MC5135	20	MC5183	17	MC6032	24	MC7142	59
MC5136	20	MC5184	17	MC6033	24	MC7143	59
MC5137	20	MC5185	17	MC6034	24	MC7144	59
MC5138	20	MC5186	17	MC6035	24	MC7145	59
MC5139	20	MC5187	17	MC6036	24	MC7146	59
MC5140	21	MC5188	17	MC7001	59	MC7147	59
MC5141	21	MC5189	17	MC7003	59	MC7148	59
MC5142	21	MC5190	17	MC7004	59	MC7149	59
MC5143	21	MCS191	17	MC7006	59	MC7150	59
MC5144	21	MC5192	17	MC7007	59	MC71S1	59
MC5145	21	MC5193	18	MC7008	59	MC7152	59
MC5146	21	MC5194	18	MC7009	59	MC7153	59
MC5147	21	MC5195	18	MC7010	59	MC7154	59
MC5148	21	MC5196	18	MC7011	59	MC8008	19

INDEX

MC8009	19	MC9111-48	62	MC9117-72	63	MC9128-72	64
MC8010	19	MC9111-60	62	MC9119-12	63	MC9129-12	64
MC8011	19	MC9111-72	62	MC9119-24	63	MC9129-24	64
MC8012	19	MC9111-84	62	MC9119-36	63	MC9129-36	64
MC8013	19	MC9111-96	62	MC9119-48	63	MC9129-48	64
MC9088	60	MC9111-108	62	MC9119-60	63	MC9129-60	64
MC9089	60	MC9111-120	62	MC9119-72	63	MC9129-72	64
MC9090	60	MC9111-144	62	MC9120-12	63	MC9130-12	64
M09091	60	MC9112-12	62	MC9120-24	63	MC9130-24	64
MC9092	60	MC9112-24	62	MC9120-36	63	MC9130-36	64
MC9093	60	MC9112-36	62	MC9120-45	63	MC9130-46	64
MC9094	60	MC9112-46	62	MC9120-60	63	MC9130-60	64
MC9095	60	MC9112-60	62	MC9120-72	63	MC9130-72	64
MC9096	60	MC9112-72	62	MC9121-12	63	MC9131-12	64
MC9097	60	MC9112-84	62	MC9121-24	63	MC9131-24	64
MC9098	60	MC9112-96	62	MC9121-36	63	MC9131-36	64
MC9099	60	MC9112-108	62	MC9121-48	63	MC9131-48	64
MC9100	60	MC9112-120	62	MC9121-60	63	MC9131-60	64
MC9101	60	MC9112-144	62	MC9121-72	63	MC9131-72	64
MC9102	60	MC9113-12	62	MC9122-12	63	MC9132-12	65
MC9103	60	MC9113-24	62	MC9122-24	63	MC9132-24	65
MC9104	60	MC9113-36	62	MC9122-36	63	MC9132-36	65
MC9105	60	MC9113-48	62	MC9122-48	63	MC9132-48	65
MC9106	60	MC9113-60	62	MC9122-60	63	MC9132-60	65
MC9107	60	MC9113-72	62	MC9122-72	63	MC9132-72	65
MC9108	60	MC9114-12	62	MC9124-12	64	MC9133-12	65
MC9109-12	62	MC9114-24	62	MC9124-24	64	MC9133-24	65
MC9109-16	62	MC9114-36	62	MC9124-36	64	MC9133-36	65
MC9109-24	62	MC9114-48	62	MC9124-48	64	MC9133-48	65
MC9109-30	62	M09114-60	62	MC9124-60	64	MC9133-60	65
MC9109-36	62	MC9114-72	62	MC9124-72	64	MC9133-72	65
MC9109-48	62	MC9115-12	63	MC9125-12	64	MC9134-6	65
MC9109-60	62	MC9115-24	63	MC9125-24	64	MC9134-12	65
MC9109-72	62	MC9115-36	63	MC9125-36	64	MC9134-18	65
MC9109-84	62	MC9115-48	63	MC9125-48	64	MC9134-24	65
MC9109-96	62	MC9115-60	63	MC9125-60	64	MC9134-36	65
MC9109-108	62	MC9115-72	63	MC9125-72	64	MC9134-48	65
MC9109-120	62	MC9116-12	63	MC9126-12	64	MC9134-60	65
MC9109-144	62	MC9116-24	63	MC9126-24	64	MC9134-72	65
MC9110-12	62	MC9116-36	63	MC9126-36	64	MC9135-12	65
MC9110-24	62	MC9116-48	63	MC9126-48	64	MC9135-24	65
MC9110-36	62	MC9116-60	63	MC9126-60	64	MC9135-36	65
MC9110-46	62	MC9116-72	63	MC9126-72	64	MC9135-48	65
MC9110-60	62	MC9117-12	63	MC9128-12	64	MC9135-60	65
MC9110-72	62	MC9117-24	63	MC9128-24	64	MC9135-72	65
MC9111-12	62	MC9117-36	63	MC9128-36	64	MC9136-12	65
MC9111-24	62	MC9117-48	63	MC9128-48	64	MC9136-24	65
MC9111-36	62	MC9117-60	63	MC9126-60	64	MC9136-36	65

INDEX

MC9136-48	65	MC9144-24	66	MC9150-24	67	MC9160-12	70
MC9136-60	65	MC9144-36	66	MC9150-36	67	MC9160-18	70
MC9136-72	65	MC9144-48	66	MC9150-48	67	MC9160-24	70
MC9137-6	65	MC9144-60	66	MC9150-60	67	MC9160-36	70
MC9137-12	65	MC9144-72	66	MC9150-72	67	MC9160-48	70
MC9137-18	65	MC9145-6	67	MC9152-12	68	MC9160-60	70
MC9137-24	65	MC9145-12	67	MC9152-24	68	MC9160-72	70
MC9137-36	65	MC9145-18	67	MC9152-36	68	MC9161-6	70
MC9137-48	65	MC9145-24	67	MC9152-48	68	MC9161-12	70
MC9137-60	65	MC9145-36	67	MC9152-60	68	MC9161-18	70
MC9137-72	65	MC9145-48	67	MC9152-72	68	MC9161-24	70
MC9138-12	65	MC9145-60	67	MC9153-12	68	MC9161-36	70
MC9138-24	65	MC9145-72	67	MC9153-24	68	MC9161-48	70
MC9138-36	65	MC9146-6	67	MC9153-36	68	MC9161-60	70
MC9138-48	65	MC9146-12	67	MC9153-48	68	MC9161-72	70
MC9138-60	65	MC9146-18	67	MC9153-60	68	MC9162-6	70
MC9138-72	65	MC9146-24	67	MC9153-72	68	MC9162-12	70
MC9139-12	66	MC9146-36	67	MC9154-12	68	MC9162-18	70
MC9139-24	66	MC9146-48	67	MC9154-24	68	MC9162-24	70
MC9139-36	66	MC9146-60	67	MC9154-36	68	MC9162-36	70
MC9139-48	66	MC9146-72	67	MC9154-48	68	MC9162-48	70
MC9139-60	66	MC9147-6	67	MC9154-60	68	MC9162-60	70
MC9139-72	66	MC9147-12	67	MC9154-72	68	MC9162-72	70
MC9140-12	66	MC9147-18	67	MC9155-12	68	MC9163-6	70
MC9140-24	66	MC9147-24	67	MC9155-24	68	MC9163-12	70
MC9140-36	66	MC9147-36	67	MC9155-36	68	MC9163-18	70
MC9140-48	66	MC9147-48	67	MC9155-48	68	MC9163-24	70
MC9140-60	66	MC9147-60	67	MC9155-60	68	MC9163-36	70
MC9140-72	66	MC9147-72	67	MC9155-72	68	MC9163-48	70
MC9141-12	66	MC9148-6	67	MC9157-12	68	MC9163-60	70
MC9141-24	66	MC9148-12	67	MC9157-24	68	MC9163-72	70
MC9141-36	66	MC9148-18	67	MC9157-36	68	MC9164-6	70
MC9141-48	66	MC9148-24	67	MC9157-48	68	MC9164-12	70
MC9141-60	66	MC9148-36	67	MC9157-60	68	MC9164-18	70
MC9141-72	66	MC9148-48	67	MC9157-72	68	MC9164-24	70
MC9142-12	66	MC9148-60	67	MC9158-12	68	MC9164-36	70
MC9142-24	66	MC9148-72	67	MC9158-24	68	MC9164-48	70
MC9142-36	66	MC9149-6	67	MC9158-36	68	MC9164-60	70
MC9142-48	66	MC9149-12	67	MC9158-48	68	MC9164-72	70
MC9142-60	66	MC9149-18	67	MC9158-60	68	MC9165-6	70
MC9142-72	66	MC9149-24	67	MC9158-72	68	MC9165-12	70
MC9143-12	66	MC9149-36	67	MC9159-12	68	MC9165-16	70
MC9143-24	66	MC9149-48	67	MC9159-24	68	MC9165-24	70
MC9143-36	66	MC9149-60	67	MC9159-36	68	MC9165-36	70
MC9143-48	66	MC9149-72	67	MC9159-48	68	MC9165-48	70
MC9143-60	66	MC9150-6	67	MC9159-60	68	MC9165-60	70
MC9143-72	66	MC9150-12	67	MC9159-72	68	MC9165-72	70
MC9144-12	66	MC9150-18	67	MC9160-6	70	MC9166-6	70

INDEX

MC9166-12	70	MC9173-12	71	MC9180-12	72	MC9189-12	73
MC9166-18	70	MC9173-18	71	MC9180-18	72	MC9189-18	73
MC9166-24	70	MC9173-24	71	MC9180-24	72	MC9189-24	73
MC9166-36	70	MC9173-36	71	MC9180-36	72	MC9189-36	73
MC9166-48	70	MC9173-48	71	MC9180-48	72	MC9189-48	73
MC9166-60	70	MC9173-60	71	MC9180-60	72	MC9189-60	73
MC9166-72	70	MC9173-72	71	MC9180-72	72	MC9189-72	73
MC9167-6	70	MC9174-6	71	MC9183-6	72	MC9190-6	73
MC9167-12	70	MC9174-12	71	MC9183-12	72	MC9190-12	73
MC9167-18	70	MC9174-18	71	MC9183-18	72	MC9190-16	73
MC9167-24	70	MC9174-24	71	MC9183-24	72	MC9190-24	73
MC9167-36	70	MC9174-36	71	MC9163-36	72	MC9190-36	73
MC9167-48	70	MC9174-48	71	MC9163-48	72	MC9190-48	73
MC9167-60	70	MC9174-60	71	MC9163-60	72	MC9190-60	73
MC9167-72	70	MC9174-72	71	MC9163-72	72	MC9190-72	73
MC9168-6	71	MC9175-6	71	MC9164-6	72	MC9193-6	73
MC9168-12	71	MC9175-12	71	MC9184-12	72	MC9193-12	73
MC9166-18	71	MC9175-18	71	MC9184-18	72	MC9193-18	73
MC9168-24	71	MC9175-24	71	MC9184-24	72	MC9193-24	73
MC9168-36	71	MC9175-36	71	MC9184-36	72	MC9193-36	73
MC9168-48	71	MC9175-48	71	MC9184-48	72	MC9193-48	73
MC9168-60	71	MC9175-60	71	MC9184-60	72	MC9193-60	73
MC9168-72	71	MC9175-72	71	MC9184-72	72	MC9193-72	73
MC9169-6	71	MC9176-6	71	MC9185-6	72	MC9194-6	73
MC9169-12	71	MC9176-12	71	MC9185-12	72	MC9194-12	73
MC9169-18	71	MC9176-18	71	MC9185-18	72	MC9194-18	73
MC9169-24	71	MC9176-24	71	MC9185-24	72	MC9194-24	73
MC9169-36	71	MC9176-36	71	MC9185-36	72	MC9194-36	73
MC9169-48	71	MC9176-48	71	MC9185-48	72	MC9194-48	73
MC9169-60	71	MC9176-60	71	MC9185-60	72	MC9194-60	73
MC9169-72	71	MC9176-72	71	MC9185-72	72	MC9194-72	73
MC9170-6	71	MC9178-6	72	MC9186-6	72	MC9195-6	73
MC9170-12	71	MC9178-12	72	MC9186-12	72	MC9195-12	73
MC9170-18	71	MC9178-18	72	MC9186-18	72	MC9195-18	73
MC9170-24	71	MC9178-24	72	MC9186-24	72	MC9195-24	73
MC9170-36	71	MC9178-36	72	MC9186-36	72	MC9195-36	73
MC9170-48	71	MC9178-48	72	MC9186-48	72	MC9195-48	73
MC9170-60	71	MC9178-60	72	MC9186-60	72	MC9195-60	73
MC9170-72	71	MC9178-72	72	MC9186-72	72	MC9195-72	73
MC9171-6	71	MC9179-6	72	MC91BB-6	73	MC9196-6	73
MC9171-12	71	MC9179-12	72	MC9188-12	73	MC9196-12	73
MC9171-18	71	MC9179-18	72	MC9186-18	73	MC9196-18	73
MC9171-24	71	MC9179-24	72	MC9188-24	73	MC9196-24	73
MC9171-36	71	MC9179-36	72	MC9188-36	73	MC9196-36	73
MC9171-46	71	MC9179-48	72	MC9188-48	73	MC9196-46	73
MC9171-60	71	MC9179-60	72	MC9188-60	73	MC9196-60	73
MC9171-72	71	MC9179-72	72	MC9168-72	73	MC9196-72	73
MC9173-6	71	MC9180-6	72	MC9189-6	73	MC9197-6	74

INDEX

MC9197-12	74	MC9206-12	74	MC9213-12	75	MC9221-48	76
MC9197-18	74	MC9206-18	74	MC9213-18	75	MC9221-60	76
MC9197-24	74	MC9206-24	74	MC9213-24	75	MC9221-72	76
MC9197-36	74	MC9206-36	74	MC9213-36	75	MC9222-12	76
MC9197-48	74	MC9206-48	74	MC9213-48	75	MC9222-24	76
MC9197-60	74	MC9206-60	74	MC9213-60	75	MC9222-36	76
MC9197-72	74	MC9206-72	74	MC9213-72	75	MC9222-48	76
MC9198-6	74	MC9205-6	75	MC9214-6	75	MC9222-60	76
MC9198-12	74	MC9208-12	75	MC9214-12	75	MC9222-72	76
MC9198-18	74	MC9208-18	75	MC9214-18	75	MC9224-12	77
MC9198-24	74	MC9208-24	75	MC9214-24	75	MC9224-24	77
MC9198-36	74	MC9208-36	75	MC9214-36	75	MC9224-36	77
MC9198-48	74	MC9208-48	75	MC9214-46	75	MC9224-46	77
MC9195-60	74	MC9208-60	75	MC9214-60	75	MC9224-60	77
MC9198-72	74	MC9206-72	75	MC9214-72	75	MC9224-72	77
MC9199-6	74	MC9209-6	75	MC9216-12	76	MC9225-6	77
MC9199-12	74	MC9209-12	75	MC9216-24	76	MC9225-12	77
MC9199-15	74	MC9209-16	75	MC9216-36	76	MC9225-18	77
MC9199-24	74	MC9209-24	75	MC9216-48	76	MC9225-24	77
MC9199-36	74	MC9209-36	75	MC9216-60	76	MC9225-30	77
MC9199-48	74	MC9209-48	75	MC9216-72	76	MC9225-36	77
MC9199-60	74	MC9209-60	75	MC9217-12	76	MC9225-48	77
MC9199-72	74	MC9209-72	75	MC9217-24	76	MC9225-60	77
MC9203-6	74	MC9210-6	75	MC9217-36	76	MC9225-72	77
MC9203-12	74	MC9210-12	75	MC9217-48	76	MC9226-12	77
MC9203-16	74	MC9210-18	75	MC9217-60	76	MC9226-24	77
MC9203-24	74	MC9210-24	75	MC9217-72	76	MC9226-36	77
MC9203-36	74	MC9210-36	75	MC9216-12	76	MC9226-48	77
MC9203-48	74	MC9210-48	75	MC9218-24	76	MC9226-60	77
MC9203-60	74	MC9210-60	75	MC9218-36	76	MC9226-72	77
MC9203-72	74	MC9210-72	75	MC9218-48	76	MC9227-12	77
MC9204-6	74	MC9211-6	75	MC9216-60	76	MC9227-24	77
MC9204-12	74	MC9211-12	75	MC9218-72	76	MC9227-36	77
MC9204-18	74	MC9211-18	75	MC9219-12	76	MC9227-48	77
MC9204-24	74	MC9211-24	75	MC9219-24	76	MC9227-60	77
MC9204-36	74	MC9211-36	75	MC9219-36	76	MC9227-72	77
MC9204-48	74	MC9211-48	75	MC9219-48	76	MC9227-84	77
MC9204-60	74	MC9211-60	75	MC9219-60	76	MC9227-96	77
MC9204-72	74	MC9211-72	75	MC9219-72	76	MC9227-108	77
MC9205-6	74	MC9212-6	75	MC9220-12	76	MC9227-120	77
MC9205-12	74	MC9212-12	75	MC9220-24	76	MC9227-144	77
MC9205-18	74	MC9212-18	75	MC9220-36	76	MC9228-12	77
MC9205-24	74	MC9212-24	75	MC9220-48	76	MC9228-24	77
MC9205-36	74	MC9212-36	75	MC9220-60	76	MC9228-36	77
MC9205-48	74	MC9212-46	75	MC9220-72	76	MC9228-48	77
MC9205-60	74	MC9212-60	75	MC9221-12	76	MC9228-60	77
MC9205-72	74	MC9212-72	75	MC9221-24	76	MC9228-72	77
MC9206-6	74	MC9213-6	75	MC9221-36	76	MC9226-84	77

INDEX

MC9228-96	77	MC9235-72	78	MC9244-72	79	MC9258-72	80
MC9228-108	77	MC9236-12	78	MC9246-12	79	MC9259-12	80
MC9228-120	77	MC9236-24	78	MC9246-24	79	MC9259-24	80
MC9228-144	77	MC9236-36	78	MC9246-36	79	MC9259-36	80
MC9229-6	77	MC9236-48	78	MC9246-48	79	MC9259-48	80
MC9229-12	77	MC9236-60	78	MC9246-60	79	MC9259-60	80
MC9229-18	77	MC9236-72	78	MC9246-72	79	MC9259-72	80
MC9229-24	77	MC9237-12	78	MC9251-12	79	MC9260-12	80
MC9229-30	77	MC9237-24	78	MC9251-24	79	MC9260-24	80
MC9229-36	77	MC9237-36	78	MC9251-36	79	MC9260-36	80
MC9229-48	77	MC9237-48	78	MC9251-48	79	MC9260-48	80
MC9229-60	77	MC9237-60	78	MC9251-60	79	MC9260-60	80
MC9229-72	77	MC9237-72	78	MC9251-72	79	MC9260-72	80
MC9230-12	77	MC9239-12	78	MC9252-12	80	MC9261-12	80
MC9230-24	77	MC9239-24	78	MC9252-24	80	MC9261-24	80
MC9230-36	77	MC9239-36	78	MC9252-36	80	MC9261-36	80
MC9230-48	77	MC9239-48	78	MC9252-48	80	MC9261-48	80
MC9230-60	77	MC9239-60	78	MC9252-60	80	MC9261-60	80
MC9230-72	77	MC9239-72	78	MC9252-72	80	MC9261-72	80
MC9231-12	77	MC9240-12	78	MC9253-12	80	MC9262-12	81
MC9231-24	77	MC9240-24	78	MC9253-24	80	MC9262-24	81
MC9231-36	77	MC9240-36	78	MC9253-36	80	MC9262-36	81
MC9231-48	77	MC9240-48	78	MC9253-48	80	MC9262-48	81
MC9231-60	77	MC9240-60	78	MC9253-60	80	MC9262-60	81
MC9231-72	77	MC9240-72	78	MC9253-72	80	MC9262-72	81
MC9232-12	77	MC9241-12	79	MC9254-12	80	MC9263-12	81
MC9232-24	77	MC9241-24	79	MC9254-24	80	MC9263-24	81
MC9232-36	77	MC9241-36	79	MC9254-36	80	MC9263-36	81
MC9232-48	77	MC9241-48	79	MC9254-48	80	MC9263-48	81
MC9232-60	77	MC9241-60	79	MC9254-60	80	MC9263-60	81
MC9232-72	77	MC9241-72	79	MC9254-72	80	MC9263-72	81
MC9233-12	78	MC9242-12	79	MC9255-12	80	MC9264-12	81
MC9233-24	78	MC9242-24	79	MC9255-24	80	MC9264-24	81
MC9233-36	78	MC9242-36	79	MC9255-36	80	MC9264-36	81
MC9233-48	78	MC9242-48	79	MC9255-48	80	MC9264-48	81
MC9233-60	78	MC9242-60	79	MC9255-60	80	MC9264-60	81
MC9233-72	78	MC9242-72	79	MC9255-72	80	MC9264-72	81
MC9234-12	78	MC9243-12	79	MC9256-12	80	MC9265-12	81
MC9234-24	78	MC9243-24	79	MC9256-24	80	MC9265-24	81
MC9234-36	78	MC9243-36	79	MC9256-36	80	MC9265-36	81
MC9234-48	78	MC9243-48	79	MC9256-48	80	MC9265-48	81
MC9234-60	78	MC9243-60	79	MC9256-60	80	MC9265-60	81
MC9234-72	78	MC9243-72	79	MC9256-72	80	MC9265-72	81
MC9235-12	78	MC9244-12	79	MC9258-12	80	MC9266-12	81
MC9235-24	78	MC9244-24	79	MC9258-24	80	MC9266-24	81
MC9235-36	78	MC9244-36	79	MC9258-36	80	MC9266-36	81
MC9235-48	78	MC9244-48	79	MC9258-48	80	MC9266-48	81
MC9235-60	78	MC9244-60	79	MC9258-60	80	MC9266-60	81

INDEX

MC9266-72	81	MC9278-72	82	MC9287-72	84	MC9297-72	86
MC9270-12	81	MC9279-12	82	MC9288-12	84	MC9298-12	86
MC9270-24	81	MC9279-24	82	MC9288-24	84	MC9298-24	86
MC9270-36	81	MC9279-36	82	MC9288-36	84	MC9298-36	86
MC9270-48	81	MC9279-48	82	MC9288-48	84	MC9298-48	86
MC9270-60	81	MC9279-60	82	MC9288-60	84	MC9298-60	86
MC9270-72	81	MC9279-72	82	MC9288-72	84	MC9298-72	86
MC9271-12	81	MC9280-12	82	MC9290-12	84	MC9300-12	86
MC9271-24	81	MC9280-24	82	MC9290-24	84	MC9300-24	86
MC9271-36	81	MC9280-36	82	MC9290-36	84	MC9300-36	86
MC9271-48	81	MC9280-48	82	MC9290-48	84	MC9300-48	86
MC9271-60	81	MC9280-60	82	MC9290-60	84	MC9300-60	86
MC9271-72	81	MC9280-72	82	MC9290-72	84	MC9300-72	86
MC9272-12	82	MC9281-12	82	MC9291-12	84	MC9301-12	86
MC9272-24	82	MC9281-24	82	MC9291-24	84	MC9301-24	86
MC9272-36	82	MC9281-36	82	MC9291-36	84	MC9301-36	86
MC9272-48	82	MC9281-48	82	MC9291-48	84	MC9301-48	86
MC9272-60	82	MC9281-60	82	MC9291-60	84	MC9301-60	86
MC9272-72	82	MC9281-72	82	MC9291-72	84	MC9301-72	86
MC9273-12	82	MC9282-12	83	MC9292-12	85	MC9302-12	87
MC9273-24	82	MC9282-24	83	MC9292-24	85	MC9302-24	87
MC9273-36	82	MC9282-36	83	MC9292-36	85	MC9302-36	87
MC9273-48	82	MC9282-48	83	MC9292-48	85	MC9302-48	87
MC9273-60	82	MC9282-60	83	MC9292-60	85	MC9302-60	87
MC9273-72	82	MC9282-72	83	MC9292-72	85	MC9302-72	87
MC9274-12	82	MC9283-12	83	MC9293-12	85	MC9303-12	87
MC9274-24	82	MC9283-24	83	MC9293-24	85	MC9303-24	87
MC9274-36	82	MC9283-36	83	MC9293-36	85	MC9303-36	87
MC9274-48	82	MC9283-48	83	MC9293-48	85	MC9303-48	87
MC9274-60	82	MC9283-60	83	MC9293-60	85	MC9303-60	87
MC9274-72	82	MC9283-72	83	MC9293-72	85	MC9303-72	87
MC9276-12	82	MC9285-12	83	MC9295-12	85	MC9305-12	87
MC9276-24	82	MC9285-24	83	MC9295-24	85	MC9305-24	87
MC9276-36	82	MC9285-36	83	MC9295-36	85	MC9305-36	87
MC9276-48	82	MC9285-48	83	MC9295-48	85	MC9305-48	87
MC9276-60	82	MC9285-60	83	MC9295-60	85	MC9305-60	87
MC9276-72	82	MC9285-72	83	MC9295-72	85	MC9305-72	87
MC9277-12	82	MC9288-12	83	MC9296-12	85	MC9306-12	87
MC9277-24	82	MC9286-24	83	MC9298-24	85	MC9306-24	87
MC9277-36	82	MC9286-36	83	MC9296-36	85	MC9306-36	87
MC9277-48	82	MC9286-48	83	MC9296-48	85	MC9306-48	87
MC9277-60	82	MC9286-60	83	MC9296-60	85	MC9306-60	87
MC9277-72	82	MC9286-72	83	MC9296-72	85	MC9306-72	87
MC9278-12	82	MC9287-12	84	MC9297-12	86	MC9307-6	88
MC9278-24	82	MC9287-24	84	MC9297-24	86	MC9307-12	88
MC9278-36	82	MC9287-36	84	MC9297-36	86	MC9307-18	88
MC9278-48	82	MC9287-48	84	MC9297-48	86	MC9307-24	88
MC9278-60	82	MC9287-60	84	MC9297-60	86	MC9307-36	88

INDEX

MC9307-48	88	MC9315-48	89	MC9323-48	90	MC9332-36	93
MC9307-60	88	MC9315-60	89	MC9323-60	90	MC9332-48	93
MC9307-72	88	MC9315-72	89	MC9323-72	90	MC9332-60	93
MC9308-6	88	MC9316-12	90	MC9324-12	90	MC9332-72	93
MC9308-12	88	MC9316-24	90	MC9324-24	90	MC9333-12	93
MC9308-18	88	MC9318-36	90	MC9324-38	90	MC9333-24	93
MC9305-24	88	MC9318-48	90	MC9324-48	90	MC9333-36	93
MC9308-36	88	MC9316-60	90	MC9324-60	90	MC9333-48	93
MC9305-48	88	MC9316-72	90	MC9324-72	90	MC9333-60	93
MC9308-80	88	MC9317-12	90	MC9328-12	91	MC9333-72	93
MC9308-72	88	MC9317-24	90	MC9326-18	91	MC9335-12	93
MC9310-6	88	MC9317-36	90	MC9326-24	91	MC9335-24	93
MC9310-12	88	MC9317-48	90	MC9326-36	91	MC9335-36	93
MC9310-18	88	MC9317-60	90	MC9326-48	91	MC9335-48	93
MC9310-24	88	MC9317-72	90	MC9326-60	91	MC9335-60	93
MC9310-36	88	MC9318-12	90	MC9326-72	91	MC9335-72	93
MC9310-48	88	MC9318-24	90	MC9327-12	91	MC9336-12	93
MC9310-60	88	MC9318-36	90	MC9327-24	91	MC9336-24	93
MC9310-72	88	MC9318-48	90	MC9327-36	91	MC9336-36	93
MC9311-8	88	MC9318-60	90	MC9327-48	91	MC9336-48	93
MC9311-12	88	MC9318-72	90	MC9327-60	91	MC9336-60	93
MC9311-18	88	MC9319-12	90	MC9327-72	91	MC9336-72	93
MC9311-24	88	MC9319-24	90	MC9328-12	91	MC9337-12	94
MC9311-36	88	MC9319-38	90	MC9328-24	91	MC9337-24	94
MC9311-48	88	MC9319-48	90	MC9328-36	91	MC9337-36	94
MC9311-60	88	MC9319-60	90	MC9328-48	91	MC9337-48	94
MC9311-72	88	MC9319-72	90	MC9328-60	91	MC9337-60	94
MC9312-12	89	MC9320-12	90	MC9328-72	91	MC9337-72	94
MC9312-24	89	MC9320-24	90	MC9329-12	91	MC9338-12	94
MC9312-36	89	MC9320-36	90	MC9329-24	91	MC9338-24	94
MC9312-48	89	MC9320-48	90	MC9329-36	91	MC9338-36	94
MC9312-60	89	MC9320-60	90	MC9329-48	91	MC9338-48	94
MC9312-72	89	MC9320-72	90	MC9329-60	91	MC9338-60	94
MC9313-12	89	MC9321-12	90	MC9329-72	91	MC9338-72	94
MC9313-24	89	MC9321-24	90	MC9330-12	91	MC9340-12	94
MC9313-36	89	MC9321-36	90	MC9330-24	91	MC9340-24	94
MC9313-48	89	MC9321-48	90	MC9330-36	91	MC9340-36	94
MC9313-60	89	MC9321-60	90	MC9330-48	91	MC9340-48	94
MC9313-72	89	MC9321-72	90	MC9330-60	91	MC9340-60	94
MC9314-12	89	MC9322-12	90	MC9330-72	91	MC9340-72	94
MC9314-24	89	MC9322-24	90	MC9331-12	91	MC9341-12	94
MC9314-36	89	MC9322-36	90	MC9331-24	91	MC9341-24	94
MC9314-48	89	MC9322-48	90	MC9331-36	91	MC9341-36	94
MC9314-60	89	MC9322-60	90	MC9331-48	91	MC9341-48	94
MC9314-72	89	MC9322-72	90	MC9331-60	91	MC9341-60	94
MC9315-12	89	MC9323-12	90	MC9331-72	91	MC9341-72	94
MC9315-24	89	MC9323-24	90	MC9332-12	93	MC9342-12	95
MC9315-36	89	MC9323-36	90	MC9332-24	93	MC9342-24	95

INDEX

MC9342-36	95	MC9352-36	97	MC9361-18	98	MC9371-12	99
MC9342-48	95	MC9352-48	97	MC9361-24	98	MC9371-24	99
MC9342-60	95	MC9352-60	97	MC9361-36	98	MC9371-36	99
MC9342-72	95	MC9352-72	97	MC9361-48	98	MC9371-48	99
MC9343-12	95	MC9353-12	97	MC9361-60	98	MC9371-60	99
MC9343-24	95	MC9353-24	97	MC9361-72	98	MC9371-72	99
MC9343-36	95	MC9353-36	97	MC9363-12	92	MC9372-12	99
MC9343-48	95	MC9353-48	97	MC9363-24	92	MC9372-24	99
MC9343-60	95	MC9353-60	97	MC9363-36	92	MC9372-36	99
MC9343-72	95	MC9353-72	97	MC9363-48	92	MC9372-48	99
MC9345-12	95	MC9355-12	97	MC9363-60	92	MC9372-60	99
MC9345-24	95	MC9355-24	97	MC9363-72	92	MC9372-72	99
MC9345-36	95	MC9355-36	97	MC9364-12	92	MC9373-12	99
MC9345-48	95	MC9355-48	97	MC9364-24	92	MC9373-24	99
MC9345-60	95	MC9355-60	97	MC9364-36	92	MC9373-36	99
MC9345-72	95	MC9355-72	97	MC9364-48	92	MC9373-48	99
MC9346-12	95	MC9356-12	97	MC9364-60	92	MC9373-60	99
MC9346-24	95	MC9356-24	97	MC9364-72	92	MC9373-72	99
MC9346-36	95	MC9356-36	97	MC9365-12	92	MC9374-12	99
MC9346-48	95	MC9356-48	97	MC9365-24	92	MC9374-24	99
MC9346-60	95	MC9356-60	97	MC9365-36	92	MC9374-36	99
MC9346-72	95	MC9356-72	97	MC9365-48	92	MC9374-48	99
MC9347-12	96	MC9357-6	98	MC9365-60	92	MC9374-60	99
MC9347-24	96	MC9357-12	98	MC9365-72	92	MC9374-72	99
MC9347-36	96	MC9357-18	98	MC9366-12	92	MC9375-12	99
MC9347-48	96	MC9357-24	98	MC9366-24	92	MC9375-24	99
MC9347-60	96	MC9357-36	98	MC9366-36	92	MC9375-36	99
MC9347-72	96	MC9357-48	98	MC9366-48	92	MC9375-48	99
MC9348-12	96	MC9357-60	98	MC9366-60	92	MC9375-60	99
MC9348-24	96	MC9357-72	98	MC9366-72	92	MC9375-72	99
MC9348-36	96	MC9358-6	98	MC9367-12	92	MC9376-12	99
MC9348-48	96	MC9358-12	98	MC9367-24	92	MC9376-24	99
MC9348-60	96	MC9358-18	98	MC9367-36	92	MC9376-36	99
MC9348-72	96	MC9358-24	98	MC9367-48	92	MC9376-48	99
MC9350-12	96	MC9358-36	98	MC9367-60	92	MC9376-60	99
MC9350-24	96	MC9358-48	98	MC9367-72	92	MC9376-72	99
MC9350-36	96	MC9358-60	98	MC9368-12	92	MC9377-12	100
MC9350-48	96	MC9358-72	98	MC9368-24	92	MC9377-24	100
MC9350-60	96	MC9360-6	98	MC9368-36	92	MC9377-36	100
MC9350-72	96	MC9360-12	98	MC9368-48	92	MC9377-48	100
MC9351-12	96	MC9360-18	98	MC9368-60	92	MC9377-60	100
MC9351-24	96	MC9360-24	98	MC9368-72	92	MC9377-72	100
MC9351-36	96	MC9360-36	98	MC9369-12	92	MC9378-12	100
MC9351-48	96	MC9360-48	98	MC9369-24	92	MC9378-24	100
MC9351-60	96	MC9360-60	98	MC9369-36	92	MC9378-36	100
MC9351-72	96	MC9360-72	98	MC9369-48	92	MC9378-48	100
MC9352-12	97	MC9361-6	98	MC9369-60	92	MC9378-60	100
MC9352-24	97	MC9361-12	98	MC9369-72	92	MC9378-72	100

INDEX

MC9380-12	100	MC9400-60	69	MC9406-60	69	MC9415-60	89
MC9380-24	100	MC9400-72	69	MC9406-72	69	MC9415-72	89
MC9380-36	100	MC9401-6	69	MC9408-12	83	MC9416-12	90
MC9380-48	100	MC9401-12	69	MC9408-24	83	MC9416-24	90
MC9380-60	100	MC9401-18	69	MC9408-36	83	MC9416-36	90
MC9380-72	100	MC9401-24	69	MC9408-48	83	MC9416-48	90
MC9381-12	101	MC9401-36	69	MC9408-60	83	MC9416-60	90
MC9381-24	101	MC9401-48	69	MC9408-72	83	MC9416-72	90
MC9381-36	101	MC9401-60	69	MC9409-12	84	MC9417-12	91
MC9381-48	101	MC9401-72	69	MC9409-24	84	MC9417-24	91
MC9381-60	101	MC9402-6	69	MC9409-36	84	MC9417-36	91
MC9381-72	101	MC9402-12	69	MC9409-48	84	MC9417-48	91
MC9382-12	101	MC9402-18	69	MC9409-60	84	MC9417-60	91
MC9382-24	101	MC9402-24	69	MC9409-72	84	MC9417-72	91
MC9382-36	101	MC9402-36	69	MC9410-12	85	MC9418-12	91
MC9382-48	101	MC9402-48	69	MC9410-24	85	MC9418-24	91
MC9362-60	101	MC9402-60	69	MC9410-36	85	MC9418-36	91
MC9382-72	101	MC9402-72	69	MC9410-48	85	MC9418-48	91
MC9383-12	100	MC9403-6	69	MC9410-60	85	MC9418-60	91
MC9383-24	100	MC9403-12	69	MC9410-72	85	MC9418-72	91
MC9383-36	100	MC9403-18	69	MC9411-12	86	MC9419-12	92
MC9383-46	100	MC9403-24	69	MC9411-24	86	MC9419-24	92
MC9383-60	100	MC9403-36	69	MC9411-36	86	MC9419-36	92
MC9383-72	100	MC9403-48	69	MC9411-48	86	MC9419-48	92
MC9384-12	100	MC9403-60	69	MC9411-60	86	MC9419-60	92
MC9384-24	100	MC9403-72	69	MC9411-72	86	MC9419-72	92
MC9384-36	100	MC9404-6	69	MC9412-12	87	MC9420-12	92
MC9384-48	100	MC9404-12	69	MC9412-24	87	MC9420-24	92
MC9384-60	100	MC9404-18	69	MC9412-36	87	MC9420-36	92
MC9384-72	100	MC9404-24	69	MC9412-48	87	MC9420-48	92
MC9386-12	100	MC9404-36	69	MC9412-60	87	MC9420-60	92
MC9386-24	100	MC9404-48	69	MC9412-72	87	MC9420-72	92
MC9386-36	100	MC9404-60	69	MC9413-12	88	MC9421-12	93
MC9386-48	100	MC9404-72	69	MC9413-24	88	MC9421-24	93
MC9386-60	100	MC9405-6	69	MC9413-36	88	MC9421-36	93
MC9386-72	100	MC9405-12	69	MC9413-48	88	MC9421-48	93
MC9387-12	101	MC9405-18	69	MC9413-60	88	MC9421-60	93
MC9387-24	101	MC9405-24	69	MC9413-72	88	MC9421-72	93
MC9387-36	101	MC9405-36	69	MC9414-12	89	MC9422-12	94
MC9387-46	101	MC9405-48	69	MC9414-24	89	MC9422-24	94
MC9387-60	101	MC9405-60	69	MC9414-36	89	MC9422-36	94
MC9387-72	101	MC9405-72	69	MC9414-48	89	MC9422-48	94
MC9400-6	69	MC9406-6	69	MC9414-60	89	MC9422-60	94
MC9400-12	69	MC9406-12	69	MC9414-72	89	MC9422-72	94
MC9400-18	69	MC9406-18	69	MC9415-12	89	MC9423-12	95
MC9400-24	69	MC9406-24	69	MC9415-24	89	MC9423-24	95
MC9400-36	69	MC9406-36	69	MC9415-36	89	MC9423-36	95
MC9400-48	69	MC9406-48	69	MC9415-48	89	MC9423-48	95

INDEX

MC9423-60	95	MC9431-60	101	MC9439-60	76	MC9447-60	64
MC9423-72	95	MC9431-72	101	MC9439-72	76	MC9447-72	64
MC9424-12	96	MC9432-12	82	MC9440-12	75	MC9448-12	63
MC9424-24	96	MC9432-24	82	MC9440-24	75	MC9448-24	63
MC9424-36	96	MC9432-36	82	MC9440-36	75	MC9448-36	63
MC9424-48	96	MC9432-48	82	MC9440-48	75	MC9448-48	63
MC9424-60	96	MC9432-60	82	MC9440-60	75	MC9448-60	63
MC9424-72	96	MC9432-72	82	MC9440-72	75	MC9448-72	63
MC9425-12	97	MC9433-12	81	MC9441-12	74	MC9449-12	62
MC9425-24	97	MC9433-24	81	MC9441-24	74	MC9449-24	62
MC9425-36	97	MC9433-36	81	MC9441-36	74	MC9449-36	62
MC9425-48	97	MC9433-48	81	MC9441-48	74	MC9449-48	62
MC9425-60	97	MC9433-60	81	MC9441-60	74	MC9449-60	62
MC9425-72	97	MC9433-72	81	MC9441-72	74	MC9449-72	62
MC9426-12	98	MC9434-12	80	MC9442-12	73		
MC9426-24	98	MC9434-24	80	MC9442-24	73		
MC9426-36	98	MC9434-36	80	MC9442-36	73		
MC9426-48	98	MC9434-48	80	MC9442-48	73		
MC9426-60	98	MC9434-60	80	MC9442-60	73		
MC9426-72	98	MC9434-72	80	MC9442-72	73		
MC9427-12	99	MC9435-12	79	MC9443-12	72		
MC9427-24	99	MC9435-24	79	MC9443-24	72		
MC9427-36	99	MC9435-36	79	MC9443-36	72		
MC9427-48	99	MC9435-48	79	MC9443-48	72		
MC9427-60	99	MC9435-60	79	MC9443-60	72		
MC9427-72	99	MC9435-72	79	MC9443-72	72		
MC9428-12	99	MC9436-12	79	MC9444-12	69		
MC9428-24	99	MC9436-24	79	MC9444-24	69		
MC9428-36	99	MC9436-36	79	MC9444-36	69		
MC9428-48	99	MC9436-48	79	MC9444-48	69		
MC9428-60	99	MC9436-60	79	MC9444-60	69		
MC9428-72	99	MC9436-72	79	MC9444-72	69		
MC9429-12	100	MC9437-12	78	MC9445-12	68		
MC9429-24	100	MC9437-24	78	MC9445-24	68		
MC9430-36	100	MC9437-36	78	MC9445-36	68		
MC9429-48	100	MC9437-48	78	MC9445-48	68		
MC9429-60	100	MC9437-60	78	MC9445-60	68		
MC9429-72	100	MC9437-72	78	MC9445-72	68		
MC9430-12	100	MC9438-12	77	MC9446-12	65		
MC9430-24	100	MC9438-24	77	MC9446-24	65		
MC9430-36	100	MC9438-36	77	MC9446-36	65		
MC9430-48	100	MC9438-48	77	MC9446-48	65		
MC9430-60	100	MC9438-60	77	MC9446-60	65		
MC9430-72	100	MC9438-72	77	MC9446-72	65		
MC9431-12	101	MC9439-12	76	MC9447-12	64		
MC9431-24	101	MC9439-24	76	MC9447-24	64		
MC9431-36	101	MC9439-36	76	MC9447-36	64		
MC9431-48	101	MC9439-48	76	MC9447-48	64		

STANDARD TERMS AND CONDITIONS FOR SALES

PRICES: The catalog reflects the latest pricing information available at the time of printing.
Prices shown in the catalog are subject to change without notice.

FOB POINT: OUR FACILITY AT STUART, FLORIDA

MINIMUM ORDER: \$25.00 AND MINIMUM ITEM: \$10.00

TERMS OF PAYMENT: VISA, MASTERCARD OR AMERICAN EXPRESS;
OPEN ACCOUNT OF APPROVED CREDIT ONLY.

Payment on open account must be made against Commercial Invoice only. NO VOUCHERS OR
OTHER CUSTOMER FORMS OF ANY KIND WILL BE USED. PAST DUE accounts are subject
to interest at the rate of 10 percent per annum.

METHODS OF SHIPMENT:

1. UPS SURFACE, UPS 2nd DAY AIR (BLUE) OR UPS NEXT DAY AIR (RED)
2. AIRBORNE
3. FEDERAL EXPRESS ECONOMY, STANDARD OR PRIORITY ONE

LIMITED WARRANTY: All products are covered by a limited warranty for a period of one year from
the date of shipment. This warranty is limited to the repair, replacement or credit for any items found
to be defective after inspection by Microwave Components, Inc. at its main headquarters.

APPROVAL MUST FIRST BE OBTAINED FROM MICROWAVE COMPONENTS, INC. PRIOR TO
THE RETURN OF ANY MERCHANDISE TO MICROWAVE COMPONENTS, INC. FOR INSPECTION
UNDER WARRANTY. Shipping charges for all materials returned under this Limited Warranty are to
be PREPAID BY THE CUSTOMER. ALL MATERIAL RETURNED WITHOUT A MICROWAVE
COMPONENTS, INC. RETURN MATERIAL AUTHORIZATION NUMBER WILL BE
AUTOMATICALLY REFUSED.